

SKINTOP® MS-SC/ MS-SCL

Liquid Tight, Metallic Strain Relief for EMC Shielding
Cable Gland with NPT, PG & Metric Threads

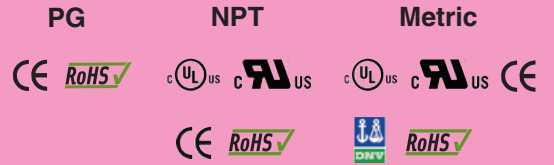

SKINTOP® MS-SC is uniquely designed to address EMC considerations with its simplified grounding feature. In a few easy steps, the cable is grounded, strain relieved and sealed from moisture and dust in accordance with IP 68. The cable gland's contact springs establish a continuous electrical path from the shield of the cable to equipment ground, creating a secure shield connection.

Application Advantage:

- Optimal EMC protection
- Suitable for braid shielded cable
- Minimal assembly steps
- The contact spring's unique design can accept cable diameters with wide dimensional tolerances
- Available in both standard and long length threads for heavy-wall applications



For standard contacting

1

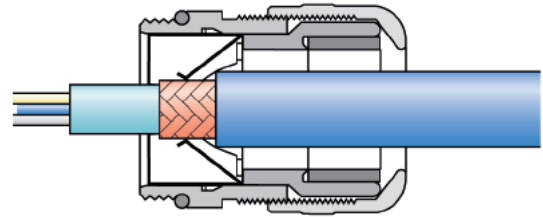

For thin wires without an inner sheath

2

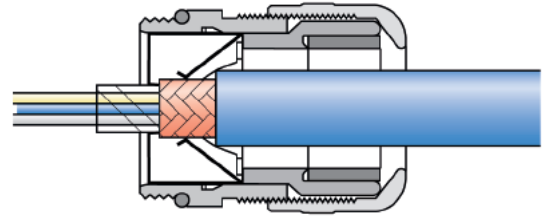

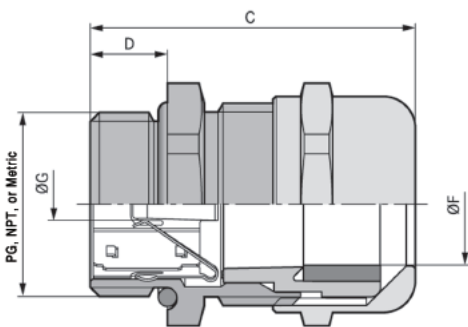
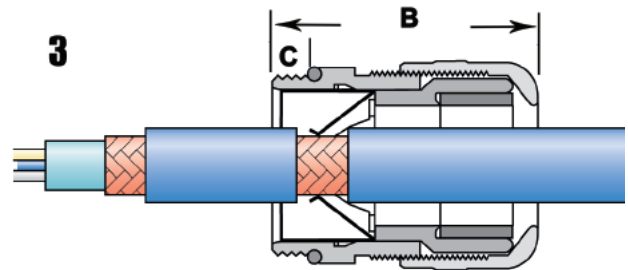

When routing the cable screen to another connection

3



Technical Data:

 Materials:	
Body:	Nickel-Plated Brass
Insert:	Polyamide
Bushing:	CR
O-Ring:	Perbunan (NBR)

 Seal: IP 68, 5 Bar *
(Exceeds NEMA 6/ 6P Pressure rating)

 Temperature Range: -30°C to +100°C

Locknuts: Add SM-PE Locknuts, see Page 523

* when used with o-ring

SKINTOP® MS-SC/ MS-SCL

Liquid Tight, Metallic Strain Relief for EMC Shielding
Cable Gland with NPT, PG & Metric Threads

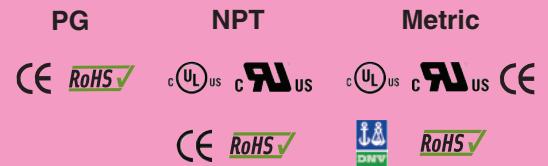

NPT THREADS

SKINTOP® MS-SC: Liquid Tight, Metallic Strain Relief Cable Gland with NPT Threads

Part Number	Thread Type & Size	Clamping Range of F inches	SW Wrenching Flats inches	C Overall Length inches	D Thread Length inches	Standard Pack Size
53112910	NPT-3/8"	0.177 - 0.354	0.787	1.563	.591	100
53112920	NPT-1/2"	0.276 - 0.492	0.945	1.673	.591	50
53112930	NPT-3/4"	0.354 - 0.650	1.142	1.752	.591	25
53112940	NPT-1"	0.433 - 0.827	1.417	1.929	.669	25
53112950	NPT-1-1/4"	0.748 - 1.102	1.772	2.264	.669	10
53112960	NPT-1-1/2"	1.063 - 1.375	2.126	2.126	.669	5

PG THREADS (not UL)

SKINTOP® MS-SC: Liquid Tight, Metallic Strain Relief Cable Gland with PG Threads

Part Number	Thread Type & Size	Clamping Range of F inches	SW Wrenching Flats inches	C Overall Length inches	D Thread Length inches	Min ø above braiding	Standard Pack Size
53112210	PG-9	.118 - 0.315	0.669	1.142	.236	.157	50
53112220	PG-11	.157 - 0.394	0.787	1.260	.236	.157	50
53112230	PG-13	.197 - 0.472	0.866	1.339	.256	.157	25
53112240	PG-16	.315 - 0.551	0.945	1.378	.256	.236	25
53112250	PG-21	.433 - 0.689	1.181	1.575	.276	.315	25
53112260	PG-29	.630 - 0.984	1.575	1.890	.315	.512	10
53112270	PG-36	.748 - 1.260	1.969	2.441	.591	.630	5

SKINTOP® MS-SCL: Liquid Tight, Metallic Strain Relief Cable Gland with Extended PG Threads

Part Number	Thread Type & Size	Clamping Range of F inches	SW Wrenching Flats inches	C Overall Length inches	D Thread Length inches	Min ø above braiding	Standard Pack Size
53112310	PG-9	.118 - .315	0.669	1.378	.472	.157	50
53112320	PG-11	.157 - .394	0.787	1.496	.472	.157	50
53112330	PG-13	.197 - .472	0.866	1.555	.472	.157	25
53112340	PG-16	.315 - .551	0.945	1.594	.472	.236	25
53112350	PG-21	.433 - .689	1.181	1.772	.472	.315	25
53112360	PG-29	.630 - .984	1.575	2.047	.591	.512	10

METRIC THREADS

SKINTOP® MS-SC-M: Liquid-Tight, Metallic Strain Relief Cable Gland with Metric Threads

Part Number	Thread Type & Size	Clamping Range of F inches	SW Wrenching Flats inches	C Overall Length inches	D Thread Length inches	Standard Pack Size
53112610	M-12X1.5	0.138 - 0.276	0.630	1.043	.256	50
53112620	M-16X1.5	0.177 - 0.354	0.787	1.299	.276	50
53112630	M-20X1.5	0.276 - 0.492	0.945	1.457	.315	25
53112640	M-25X1.5	0.354 - 0.650	1.142	1.516	.315	25
53112650	M-32X1.5	0.433 - 0.827	1.417	1.791	.354	25
53112660	M-40X1.5	0.748 - 1.102	1.772	1.890	.354	10
53112670	M-50X1.5	1.063 - 1.378	2.126	2.185	.394	5

SKINTOP® MS-SC-M-XL: Liquid-Tight, Metallic Strain Relief Cable Gland with Extended Metric Threads

Part Number	Thread Type & Size	Clamping Range of F inches	SW Wrenching Flats inches	C Overall Length inches	D Thread Length inches	Standard Pack Size
53112625	M-16X1.5	0.177 - 0.354	0.787	1.496	.472	50
53112635	M-20X1.5	0.276 - 0.492	0.945	1.614	.472	25
53112645	M-25X1.5	0.354 - 0.650	1.142	1.673	.472	25
53112655	M-32X1.5	0.433 - 0.827	1.417	2.028	.591	25
53112665	M-40X1.5	0.748 - 1.102	1.772	2.126	.591	10
53112675	M-50X1.5	1.063 - 1.378	2.126	2.382	.591	5