

EPIC® Circular Connectors

EPT Series (26482)

EPIC® EPT Series Connectors are available in four housing styles, four housing sizes, and eight contact configurations. Common to all arrangements are a rugged nickel plated aluminum alloy body, thermoplastic rubber contact insert, and gold plated electrical contacts. Cable mounted arrangements are also available with an integral 360 degree EMC shield and cable clamp with environmental seal. The figure below shows the general construction of these connectors. All housings are available with either male pin or female socket contacts.

The connectors are offered with insert configurations from 3 to 26 crimp contacts. Used in combination, they connect one cable with another (cable coupler) or a cable to fixed wiring in a control enclosure or on a machine, robot, instrument, encoder, or servo motor.

The new connectors incorporate many inherent features offering significant application advantages. These features make it one of the most application friendly connectors available, and insure quick and easy assembly, high reliability, and long, uninterrupted service life in tough industrial environments.



Straight Plug Connector

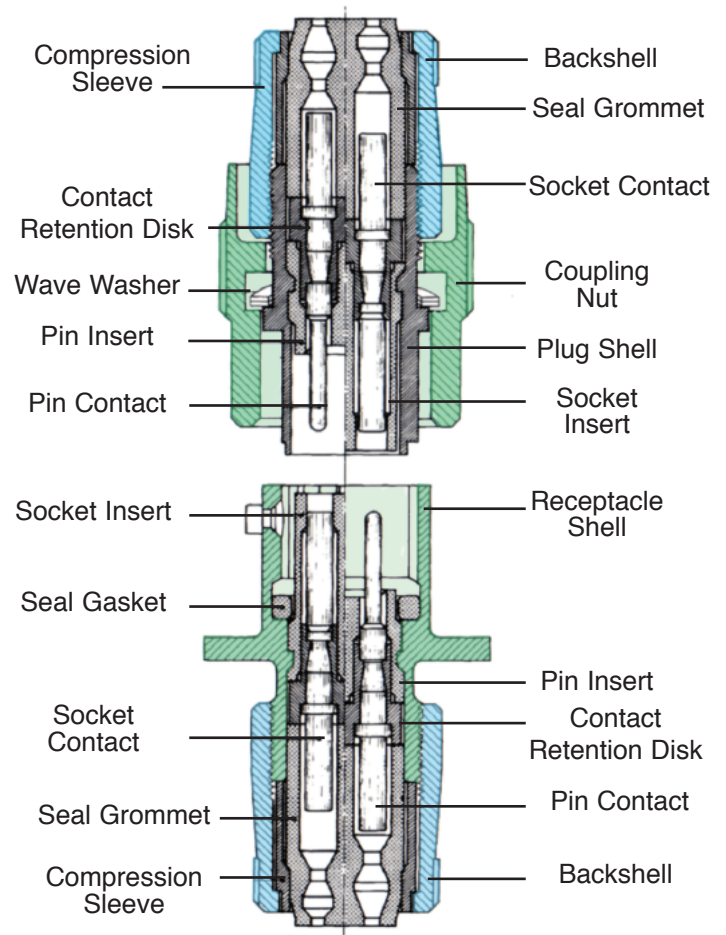

Key features include:

- Rugged Nickel-plated, Aluminum alloy body
- TPE insert material provides high degree of environmental and chemical resistance
- Three-point Bayonet Coupling provides positive vibration protection for use with motor drives and moving assemblies
- Available backshell designs provide strain-relief, IP67 protection, and 360 degree EMC shielding
- All materials used in these connectors are RoHS compliant
- Standard crimp contacts provide easy field assembly and replacement
- Fully intermateable and interchangeable with connectors produced in accordance with MIL-C-26482 Series 1 and 2

Cable Coupler Receptacle

EPIC® Circular Connectors

EPT Series (26482)

Electrical:

Number of Contacts	3 to 26					
Contact Termination	Crimp					
Contact Wire Range	Contact Size	Wire Gauge (AWG)	Insulation OD- Inch (mm)			
			Min.	Max.		
	20	24, 22, 20	.060 (1.52)	.083 (2.11)		
	16	20, 18, 16	.066 (1.68)	.109 (2.77)		
Current Rating	Contact Size	Rated Amps	Test Current (Amps)	Max. Millivolt Drop		
	20	7.5	7.5	55		
	16	13.0	13.0	49		
Voltage Rating	Altitude	Service Rating	Test Voltage		Max. Work Voltage	
			AC (rms)	DC	AC (rms)	DC
	Sea Level	1	1500	2100	600	850
		2	2300	3200	100	1400
	70,000 ft	1	375	535	300	510
		2	500	770	450	740
Mating Cycles	500 minimum					
Jacketed Cables OD (Class J&S)	0.08 to 0.83 inches (2.0 to 21 mm) depending on housing size					

Material & Environmental:

Housing:	Nickel plated aluminum alloy
Contact Insert:	TPE Synthetic Rubber UL94 V-0
Contact:	Copper alloy, gold plate per MIL-G-45204 Type II
Gaskets & Seals:	TPE Synthetic Rubber UL94 V-0
Temperature Range:	-55°C to +125°C
Environmental Seal:	Ref MIL-C-26482 (MIL-STD 202/1344) (Class J& S IP67 equiv. mated)
RoHS Compliance:	Yes
Standards:	MIL-C-26482; MIL-G-45204 Type II

Panel Mounting for Wall and Box Mount Receptacles

EPT Wall and Box Mount Receptacles are usually front mounted to avoid clearance problems with bayonet pins and coupling nuts.

Panel Cut-out

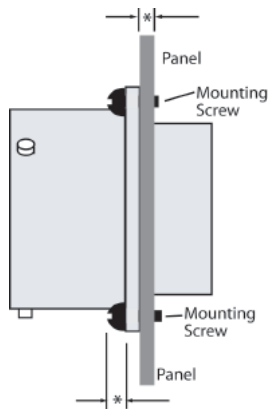
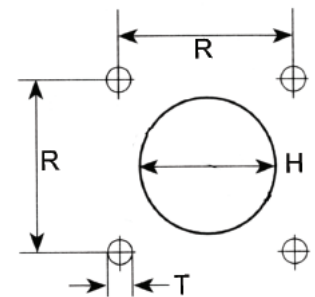

Front Panel Mounting

Maximum Panel Thickness - inches (mm)

Shell Size	Screw Height	With Backshell	Without Backshell
10	.087 (2.21)	.1 (2.54)	.25 (6.35)
12	.087 (2.21)	.1 (2.54)	.25 (6.35)
14	.087 (2.21)	.1 (2.54)	.25 (6.35)
16	.087 (2.21)	.1 (2.54)	.25 (6.35)

Dimensions in inches (mm)

Shell Size	H	R	T
10	.603 (15.3)	.719 (18.3)	.125 (3.18)
12	.730 (18.5)	.812 (20.6)	.125 (3.18)
14	.855 (21.7)	.906 (23.0)	.125 (3.18)
16	.979 (24.9)	.969 (24.6)	.125 (3.18)

EPIC® Circular Connectors

EPT Series (26482)

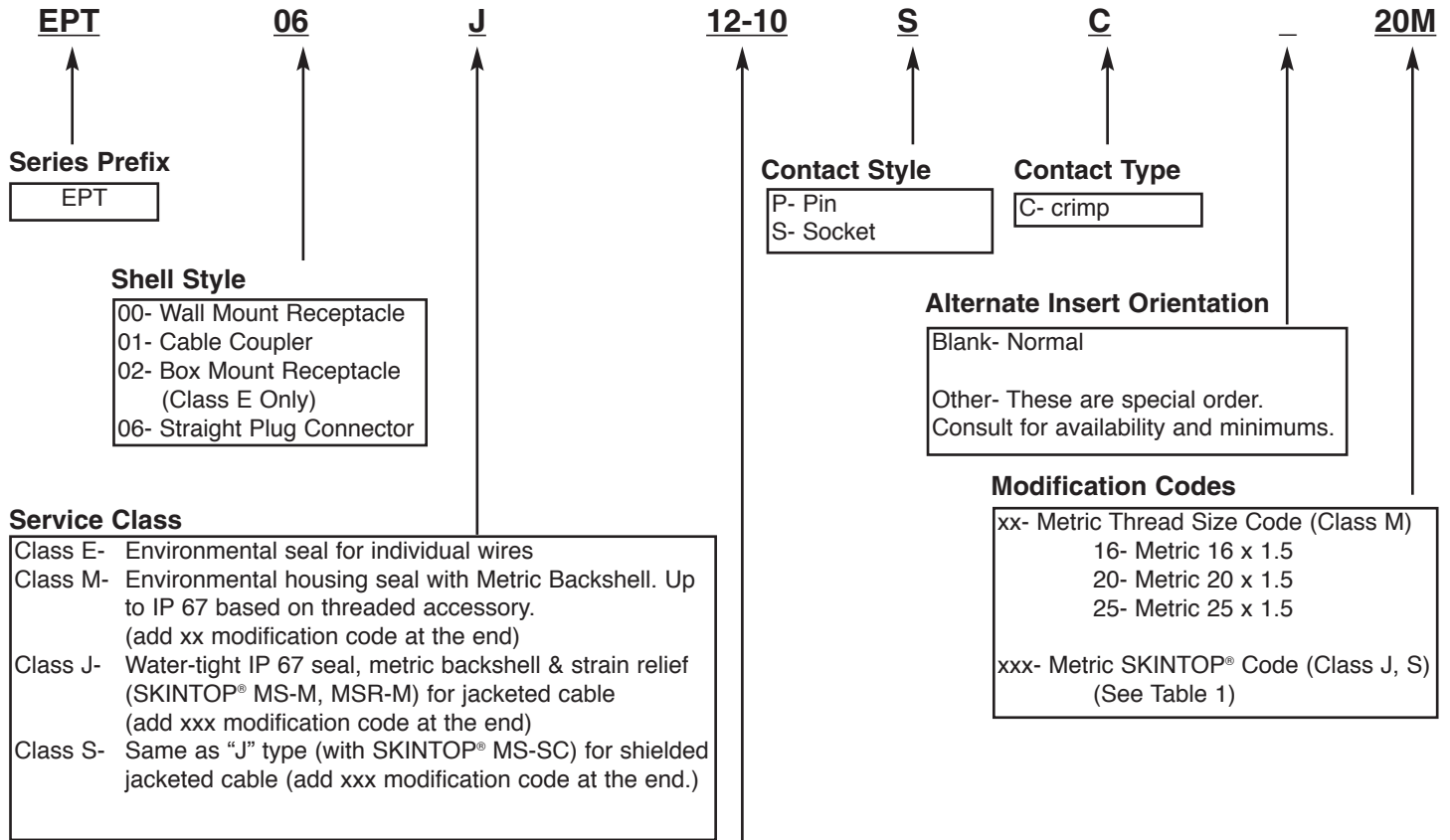

Shell Size- Contact Arrangement Code









Code	Shell Size	# of Contacts	Oper Amps	Max. Volts
10-6	10	6	7.5	600
12-10	12	10	7.5	600
14-12	14	8+4	7.5 +13	600
14-19	14	19	7.5	600
16-26	16	26	7.5	600
12-3	12	3	13	1000
14-5	14	5	13	1000
16-8	16	8	13	1000

Code	Thread Size	Shell Size	SKINTOP® Type	Reference	Cable OD Range		Service Class
					mm	inches	
16M	M16	10	MS-M	53112010	4.5 - 10	.177 - .394	J
16R			MSR-M	53112110	2 - 7	.079 - .276	J
16S			MS-SC	53112620	4.5 - 9	.177 - .354	S
20M	M20	12, 14	MS-M	53112020	7 - 13	.276 - .512	J
20R			MSR-M	53112120	5 - 10	.197 - .394	J
20S			MS-SC	53112630	7 - 12.5	.276 - .492	S
25M	M25	16	MS-M	53112030	9 - 17	.354 - .669	J
25R			MSR-M	53112130	6 - 13	.236 - .512	J
25S			MS-SC	53112640	9 - 16.5	.354 - .650	S

EPIC® Circular Connectors

EPT Series (26482)

Connector inserts follow standard MIL-C-26482 configurations and are available with either all male or all female contacts.

Shell Size	Insert	No. of Contacts	Voltage Class	Contact Size	
				16	20
10	 10-6	6	1		6
12	 12-3	3	2	3	
	 12-10	10	1		10
	 14-5	5	2	5	
14	 14-12	12	1	4	8
	 14-19	19	1		19
16	 16-8	8	2	8	
	 16-26	28	1		26

Contact Size



EPIC® Circular Connectors

EPT Series (26482)

Wall Mount Receptacle (EPT00...)

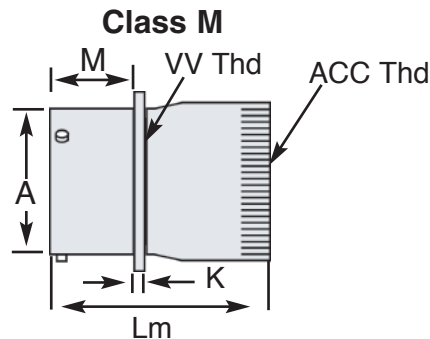
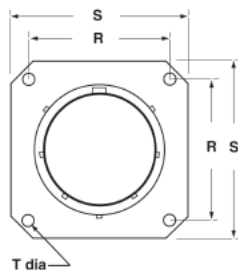

Class E

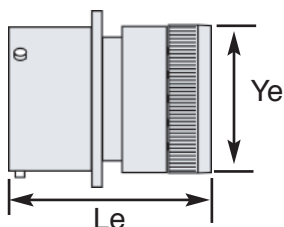

Class J & Class S

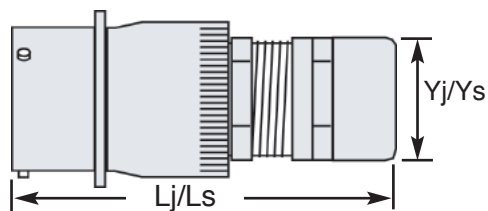

Dimensions in Inches (Millimeters)

Shell Size	A	K	Lm Max.	Le Max.	Lj/Ls Max.	M	R	S	T	Ye Max.	Yj/Ys Max.	Acc Thread	V Thread Class 2 A
10	.588 (14.94)	.062 (.157)	1.624 (41.3)	1.281 (32.54)	2.608 (66.2)	.431 (10.95)	.719 (18.26)	.954 (24.23)	.120 (3.05)	.734 (18.64)	.894 (22.7)	M16	9/16-24 UNEF
12	.748 (19.0)	.062 (.157)	1.624 (41.3)	1.281 (32.54)	2.709 (68.8)	.431 (10.95)	.812 (20.63)	1.047 (26.59)	.120 (3.05)	.858 (21.79)	1.075 (27.3)	M20	11/16-24 UNEF
14	.873 (22.17)	.062 (.157)	1.624 (41.3)	1.281 (32.54)	2.709 (68.8)	.431 (10.95)	.906 (23.01)	1.141 (28.98)	.120 (3.05)	.984 (24.99)	1.075 (27.3)	M20	13/16-20 UNEF
16	.998 (25.35)	.062 (1.57)	1.742 (44.3)	1.281 (32.54)	2.903 (73.7)	.431 (10.95)	.969 (24.61)	1.234 (31.34)	.120 (3.05)	1.110 (28.19)	1.280 (32.5)	M25	15/16-20 UNEF

Application: Wall/ panel mounting connector. Mates with housing style EPT06.

Note: "L" dimension equals total connector length including cable accessory.

EPIC® Circular Connectors

EPT Series (26482)

Box Mount Receptacle (EPT02...)

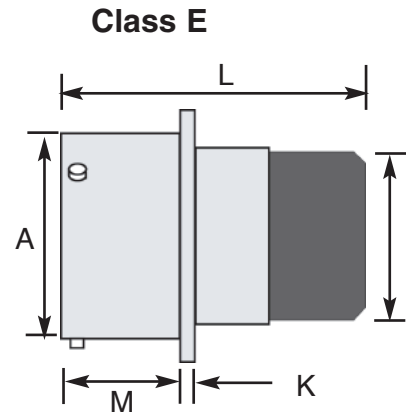
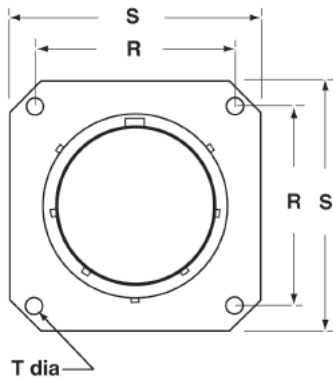

Dimensions in Inches (Millimeters)								
Shell Size	A	K	L Max	M	N	R	S	T
10	.588 (14.94)	.062 (.157)	1.320 (33.53)	.431 (10.95)	.558 (14.27)	.719 (18.26)	.954 (24.23)	.120 (3.05)
12	.748 (19.0)	.062 (1.57)	1.320 (33.53)	.431 (10.95)	.688 (17.48)	.812 (20.62)	1.047 (26.59)	.120 (3.05)
14	.873 (22.17)	.062 (1.57)	1.320 (33.53)	.431 (10.95)	.812 (20.62)	.906 (23.01)	1.141 (28.98)	.120 (3.05)
16	.998 (25.35)	.062 (1.57)	1.320 (33.53)	.431 (10.95)	.938 (23.83)	.969 (24.61)	1.234 (31.34)	.120 (3.05)

Application: Panel mounting connector. Mates with housing style EPT06.

EPIC® Circular Connectors

EPT Series (26482)

Cable Coupler Receptacle (EPT01...)

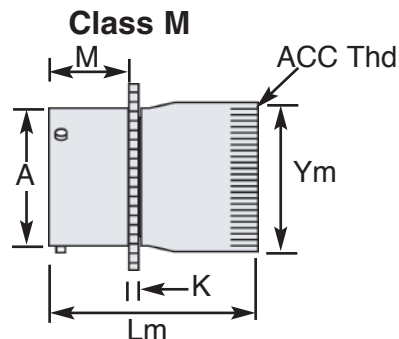
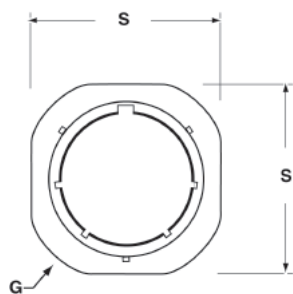

Class E

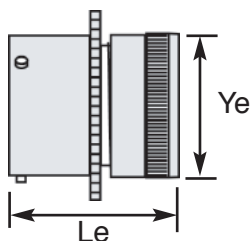

Class J & Class S

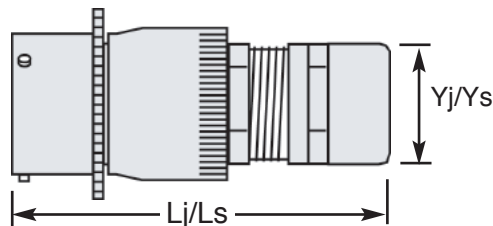

Dimensions in Inches (Millimeters)

Shell Size	A	K	Lm Max.	Le Max.	Lj/Ls Max.	M	S	G	Ym Max.	Ye Max.	Yj/Ys Max.	Acc Thread
10	.588 (14.94)	.094 (2.39)	1.624 (41.3)	1.281 (32.54)	2.608 (66.2)	.400 (10.16)	.954 (24.23)	1.062 (26.97)	.791 (20.1)	.734 (18.64)	.894 (22.7)	M16
12	.748 (19.0)	.094 (2.39)	1.624 (41.3)	1.281 (32.54)	2.709 (68.8)	.400 (10.16)	1.047 (26.59)	1.156 (29.36)	.947 (24.05)	.858 (21.79)	1.075 (27.3)	M20
14	.873 (22.17)	.094 (2.39)	1.624 (41.3)	1.281 (32.54)	2.709 (68.8)	.400 (10.16)	1.141 (28.98)	1.250 (31.75)	.947 (24.05)	.984 (24.99)	1.075 (27.3)	M20
16	.998 (25.35)	.094 (2.39)	1.742 (44.3)	1.281 (32.54)	2.903 (73.7)	.400 (10.16)	1.234 (31.34)	1.344 (34.14)	1.055 (26.8)	1.110 (28.19)	1.280 (32.5)	M25

Application: Cable coupler receptacle. Mates with housing styles EPT06

Note: L* dimension equals total connector length including cable accessory.

EPIC® Circular Connectors

EPT Series (26482)

Straight Plug Connector (EPT06...)

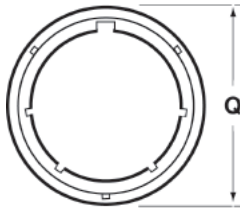

Class M

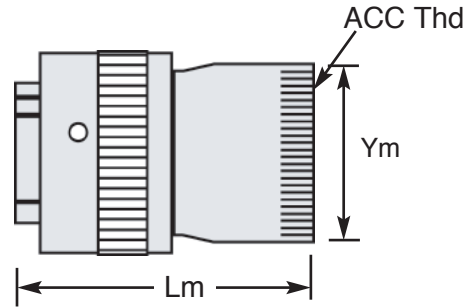

Class E

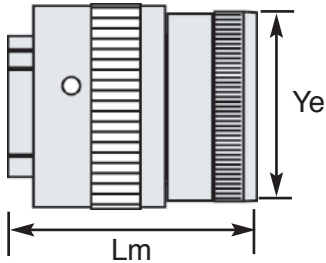

Class J & Class S

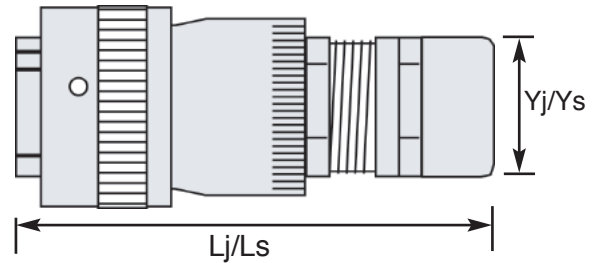

Dimensions in Inches (Millimeters)								
Shell Size	Lm Max.	Le Max	Lj/Ls Max	Q	Ym Max	Ye Max	Yj/Ys Max	Acc Thread
10	1.856 (47.15)	1.513 (38.43)	2.84 (72.14)	.926 (23.52)	.717 (18.21)	.734 (18.64)	.894 (22.7)	M16
12	1.856 (47.15)	1.513 (38.43)	2.941 (74.70)	1.043 (26.49)	.834 (21.18)	.858 (21.79)	1.075 (27.3)	M20
14	1.856 (47.15)	1.513 (38.43)	2.941 (74.70)	1.183 (30.05)	.970 (24.61)	.984 (24.99)	1.075 (27.3)	M20
16	1.974 (50.14)	1.513 (38.43)	3.135 (79.63)	1.305 (33.15)	1.088 (27.64)	1.110 (28.19)	1.280 (32.5)	M25

Application: Straight plug connector.

Mates with housing styles EPT00...; EPT01...; EPT02...

Note: L* dimension equals total connector length including cable accessory

EPIC® Circular Connectors

EPT Series (26482)

Panel Gasket



Shell Size	Flat Panel Gasket
10	61U05410
12	61U05411
14	61U05412
16	61U05413

Grommet Hole Seal Plug



Contact Size	Color	Part Number
20	Red	61U05416
16	Blue	61U05417

Crimp Contacts: Spares Only- Basic connector includes contacts

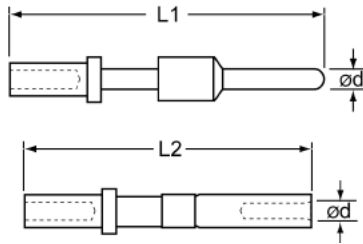

Contact Size	mm ²	AWG	L1 inches (mm)	L2 inches (mm)	ød inches (mm)	Pin	Socket	Strip Length inch (mm)
20	.23 - 0.5	24 - 20	0.915 (23.2)	0.854 (21.7)	.040 (1.0)	61U05381	61U05383	.375 (9.5)
16	0.5 - 1.5	20 - 16	0.905 (23.0)	0.844 (21.4)	.063 (1.6)	61U05382	61U05384	.250 (6.35)

Connector Dust Caps

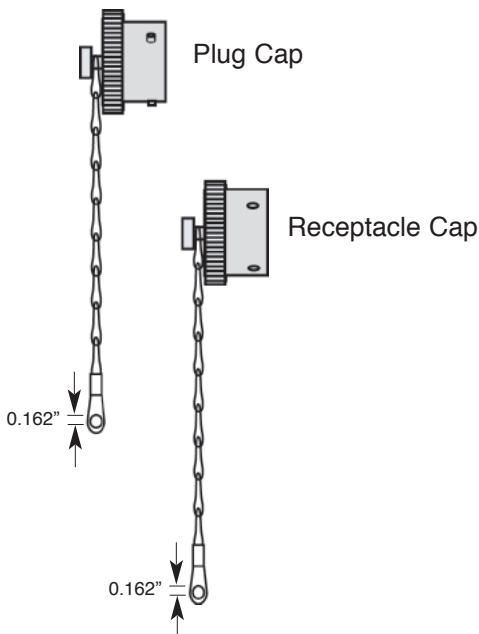

Shell Size	EAB Series	
	Plug Cap*	Receptacle Cap*
10	61U05385	61U05391
12	61U05386	61U05392
14	61U05387	61U05393
16	61U05388	61U05394

* Protective plug caps for use with EPT06... connectors

+ Protective receptacle caps for use with EPT00...; EPT01...; and EPT02... connectors

EPIC® Circular Connectors





EPT Series (26482)

Tool & Accessories

							
Contact Size	mm ²	AWG	Crimp Tool	Turret Head	Crimp Gage Go-No Go	Insertion Tool	Removal Tool
20	.25 - .52	24 - 20	61U05397	61U05398	61U05399	61U05406	61U05408
16	.52 - 1.5	20 - 16				61U05407	61U05409

SKINDICHT® Reducers, Enlargers, and Adapters

For use with Class M connectors

						
Shell Size	Class M Thread	Reducers	Enlargers	Metric to NPT	Metric to PG "A"	Metric to PG "B"
10	M16	M16/ M12 52104310	M16/ M20 52104452	M16/ 1/2" 54020100	M16/ PG7 52104200	M16/ PG 29 52104340
12, 14	M20	M20/ M16 52104312	M20/ M25 52104454	M20/ 1/2" 54020110	M20/ PG9 52104210	M20/ PG11 52104360
16	M25	M25/ M20 52104314	M25/M32 52104456	M25/ 3/4" 54020130	M25/ PG16 52104240	M25/PG21 52104400

EPIC® Circular Connectors

EPT Industrial Connectors

The EPT Series connectors are ideal for use with industrial control, data, and servo feedback cables. Based on the specific application, a wide variety of cable/ connector combinations are possible. The tables below provide a sampling of the possibilities.

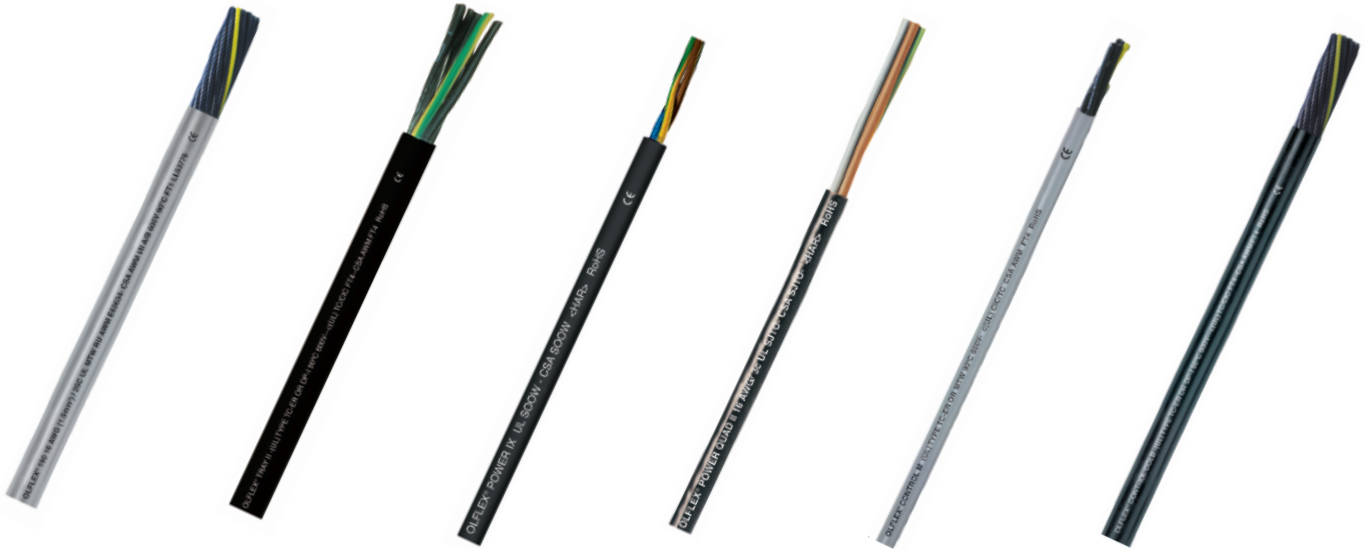

Application	Power	Control
Stationary/ Flexible	ÖLFLEX® 190/ 190 CY	ÖLFLEX® 190/ 190 CY
	ÖLFLEX® TRAY II/ II CY	ÖLFLEX® TRAY II/ II CY
	ÖLFLEX® TC 600	ÖLFLEX® CONTROL M
		ÖLFLEX® CONTROL COLD
		ÖLFLEX® AUTO I
		ÖLFLEX® TC 600
Continuous Flex	ÖLFLEX® FD 890/ 890 CY	ÖLFLEX® FD 890/ 890 CY
	ÖLFLEX® FD 891/ 891 CY	ÖLFLEX® FD 891/ 891 CY
	ÖLFLEX® FD 890P/ 890 CP	ÖLFLEX® FD 890P/ 890 CP
	ÖLFLEX® FD 891P/ 891 CP	ÖLFLEX® FD 891P/ 891 CP
	ÖLFLEX® FD 890/ 890 CY	ÖLFLEX® FD 890/ 890 CY
	ÖLFLEX® ROBOT 900 P	ÖLFLEX® ROBOT 900 P
		ÖLFLEX® FD AUTO-X

