

# EPIC® Circular Connectors

EAB & EAC Series (5015)

EPIC® EAB and EAC Series Connectors are available in four housing styles, eight housing sizes, and twelve contact configurations. Common to all arrangements are a rugged nickel plated aluminum alloy body with either threaded coupling (EAC) or bayonet coupling (EAB), thermoplastic rubber contact insert, and silver plated electrical contacts. Cable mounted arrangements are also available with an integral 360 degree EMC shield and cable clamp with environmental seal. The figure below shows the general construction of these connectors. All housings are available with either male pin or female socket contacts.

The connectors are offered with insert configurations from 3 to 37 crimp contacts. Used in combination, they connect one cable with another (cable coupler) or a cable to fixed wiring in a control enclosure or on a machine, robot, instrument, or servo motor.

The new connectors incorporate many inherent features offering significant application advantages. These features make it one of the most application friendly connectors available, and insure quick and easy assembly, high reliability, and long, uninterrupted service life in tough industrial environments.



## Key features include:

- Rugged Nickel-plated, Aluminum alloy body
- TPE insert material provides high degree of environmental and chemical resistance.
- Available backshell designs provide strain-relief, IP 67 protection, and 360 degree EMC shielding
- All materials used in these connectors are RoHS compliant.
- Standard crimp contacts provide easy field assembly and replacement.
- EAC Series are fully intermateable and interchangeable with connectors produced in accordance with MIL-C-5015.
- EAB Series uses a three-point Bayonet Coupling which provides positive vibration protection for use with motor drives and moving assemblies. They are fully intermateable and interchangeable with connectors produced in accordance with MIL-C-5015 (inserts) and VG95234 (housings).

## Straight Plug Connector

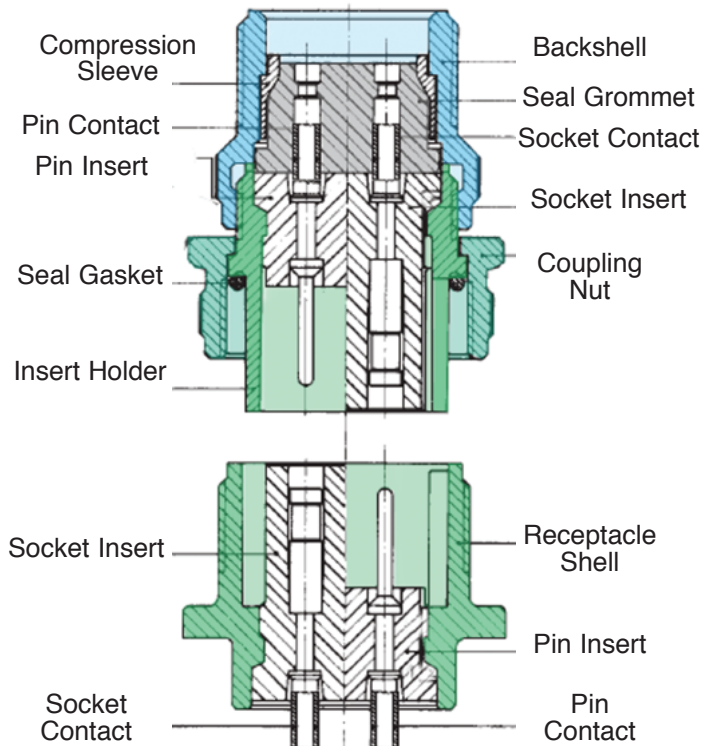

## Box Mount Receptacle

# EPIC® Circular Connectors

EAB & EAC Series (5015)

<b>Number of Contacts</b>	2 to 37			
<b>Contact Termination</b>	Crimp			
<b>Contact Wire Range</b>	<b>Contact Size</b>		<b>Wire Gauge (AWG)</b>	
	16		18, 16	
	12		14, 12	
	8		8	
<b>Current Rating</b>	<b>Contact Size</b>	<b>Rated Amps</b>	<b>Test Current (a)</b>	<b>Voltage Drop (mV)</b>
	16	13	20	21
	12	23	35	20
	8	46	60	12
<b>Voltage Rating</b>	<b>Service Rating</b>	<b>Test Voltage AC (rms)</b>	<b>Max. Work Voltage</b>	
			<b>AC (rms)</b>	<b>DC</b>
	Inst	1000	200	250
	A	2000	500	700
D	2800	900	1250	
<b>Mating Cycles</b>	500 minimum			
<b>Jacketed Cables OD (Class J&amp;S)</b>	0.08 to 1.10 inches (2.0 to 28 mm) depending on housing size			

## Panel Cut-out

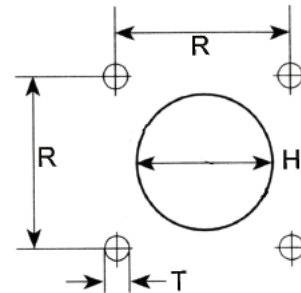

Dimensions in inches (mm)				
Shell Size	H	R	T	G
<b>10 SL</b>	.650	.717	.130	0.728
	(16.5)	(18.21)	(3.3)	(18.5)
<b>14S</b>	.774	.906	.130	0.980
	(19.7)	(23.0)	(3.3)	(24.9)
<b>16S</b>	.900	.969	.130	1.090
	(22.9)	(24.6)	(3.3)	(27.7)
<b>16</b>	.900	.969	.130	1.090
	(22.9)	(24.6)	(3.3)	(27.7)
<b>18</b>	1.028	1.063	.130	1.224
	(26.1)	(27.0)	(3.3)	(31.1)
<b>20</b>	1.150	1.157	.130	1.358
	(29.2)	(29.4)	(3.3)	(34.5)
<b>22</b>	1.276	1.252	.130	1.488
	(32.4)	(31.8)	(3.3)	(37.8)
<b>24</b>	1.402	1.374	.157	1.626
	(35.6)	(34.9)	(4.0)	(41.3)
<b>28</b>	1.650	1.563	.197	1.854
	(41.9)	(39.7)	(5.0)	(47.1)

<b>Housing:</b>	Nickel plated aluminum alloy
<b>Contact Insert:</b>	TPE Synthetic Rubber UL 94 V-0
<b>Contact:</b>	Copper alloy, silver plate per QQ-S-365
<b>Gaskets &amp; Seals:</b>	TPE Synthetic Rubber UL94 V-0
<b>Temperature Range:</b>	-55°C to +125°C
<b>Environmental Seal:</b>	Ref MIL-C-5015 (MIL-STD 202/1344) (Class J & S IP67 equiv. mated)
<b>RoHS Compliance:</b>	Yes
<b>Standards:</b>	MIL-C-5015; QQ-S-365; VG95234 (EAB Series)

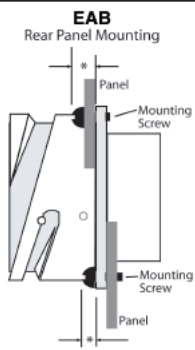

Front Panel Mounting

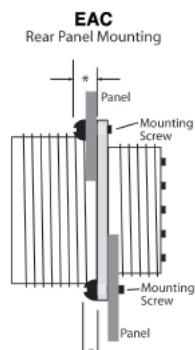

Shell Size	Maximum Panel Thickness- inches (mm)							
	EAB Series				EAB Series			
	Front Mount		Rear Mount		Front Mount		Rear Mount	
	Screw Height	With Backshell	Without Backshell	Screw + Panel	Screw Height	With Backshell	Without Backshell	Screw + Panel
<b>10SL</b>	.138 (3.5)	.1 (2.54)	.271 (6.88)	.305 (7.82)	.125 (3.18)	.1 (.254)	.271 (6.88)	.187 (4.75)
<b>14S</b>	.138 (3.5)	.1 (2.54)	.271 (6.88)	.305 (7.82)	.125 (3.18)	.1 (.254)	.271 (6.88)	.187 (4.75)
<b>16S</b>	.138 (3.5)	.1 (2.54)	.271 (6.88)	.305 (7.82)	.125 (3.18)	.1 (.254)	.271 (6.88)	.187 (4.75)
<b>16</b>	.138 (3.5)	.1 (2.54)	.271 (6.88)	.315 (8.0)	.125 (3.18)	.1 (.254)	.271 (6.88)	.125 (3.18)
<b>18</b>	.138 (3.5)	.1 (2.54)	.271 (6.88)	.305 (7.82)	.125 (3.18)	.1 (.254)	.271 (6.88)	.125 (3.18)
<b>20</b>	.138 (3.5)	.1 (2.54)	.271 (6.88)	.305 (7.82)	.125 (3.18)	.1 (.254)	.271 (6.88)	.125 (3.18)
<b>22</b>	.138 (3.5)	.1 (2.54)	.271 (6.88)	.305 (7.82)	.125 (3.18)	.1 (.254)	.271 (6.88)	.125 (3.18)
<b>24</b>	.197 (5.0)	.1 (2.54)	.271 (6.88)	.305 (7.82)	.125 (3.18)	.1 (.254)	.271 (6.88)	.187 (4.75)
<b>28</b>	.197 (5.0)	.1 (2.54)	.271 (6.88)	.315 (8.0)	.125 (3.18)	.1 (.254)	.271 (6.88)	.187 (4.75)

# EPIC® Circular Connectors

EAB & EAC Series (5015)

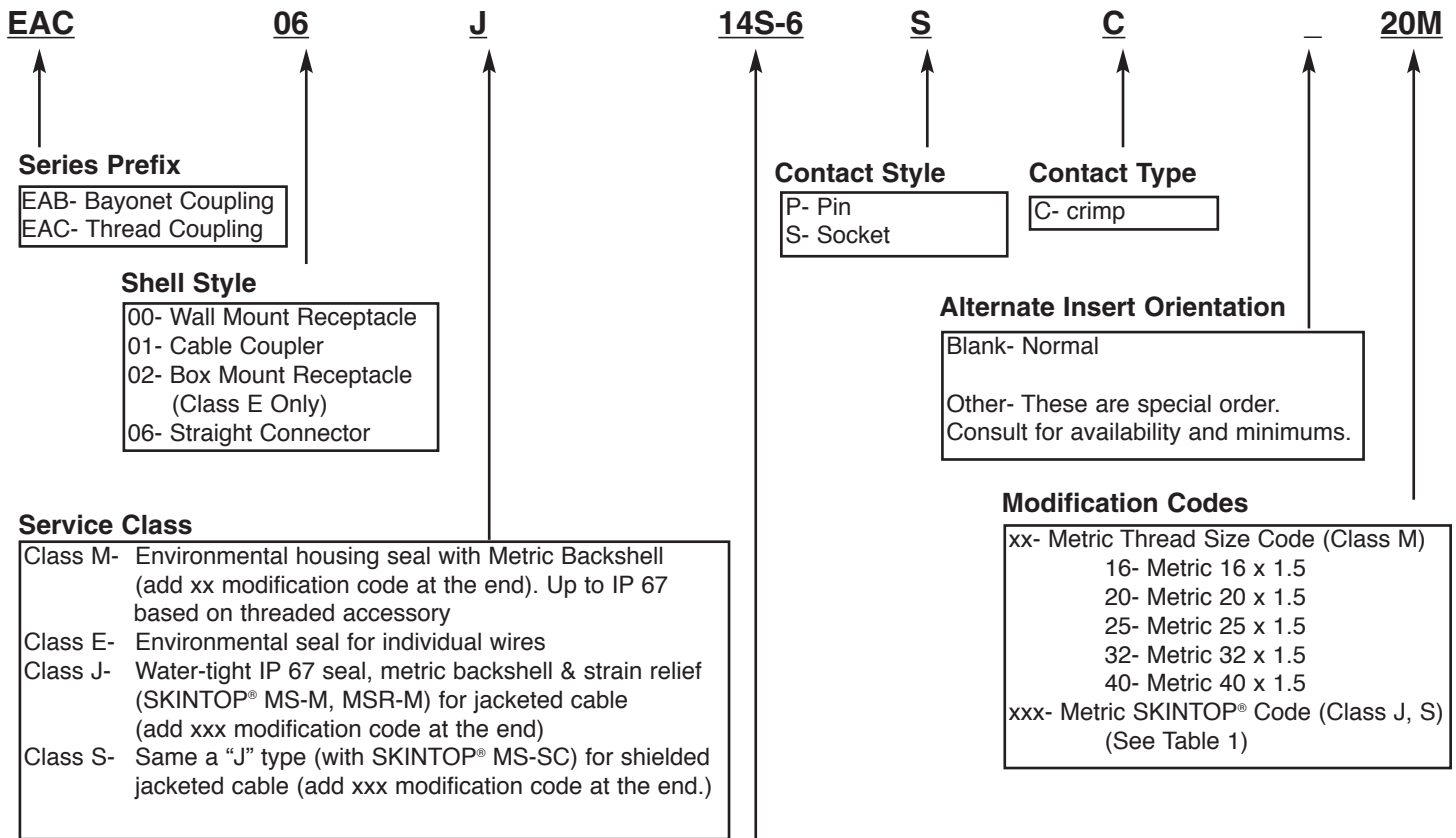

## Shell Size- Contact Arrangement Code

Code	Shell Size	# of Contacts	Oper Amps	Max. Volts
10SL-3	10	3	13	500
14S-5	14	5	113	200
14S-6	14	6	13	200
16S-1	16	7	13	500
18-1	18	10	13	(6) 200, (4) 500
20-27	20	14	13	500
20-29	20	17	13	500
28-21	28	37	13	500
16-10	16	3	23	500
20-4	20	4	23	900
22-22	22	4	46	500
24-10	24	7	46	500













## Metric SKINTOP® Selection (Table 1)

Code	Thread Size	Shell Size	SKINTOP® Type	Reference	Cable OD Range		Service Class
					mm	inches	
16M			MS-M	53112010	4.5 - 10	.177 - .394	J
16R	M16	10	MSR-M	53112110	2 - 7	.079 - .276	J
16S			MS-SC	53112620	4.5 - 9	.177 - .354	S
20M			MS-M	53112020	7 - 13	.276 - .512	J
20R	M20	14	MSR-M	53112120	5 - 10	.197 - .394	J
20S			MS-SC	53112630	7 - 12.5	.276 - .492	S
25M			MS-M	53112030	9 - 17	.354 - .669	J
25R	M25	16, 18	MSR-M	53112130	6 - 13	.236 - .512	J
25S			MS-SC	53112640	9 - 16.5	.354 - .650	S
32M			MS-M	53112040	11 - 21	.433 - .827	J
32R	M32	20, 22	MSR-M	53112140	7 - 15	.276 - .591	J
32S			MS-SC	53112650	11 - 21	.433 - .827	S
40M			MS-M	53112050	19 - 28	.748 - 1.102	J
40R	M40	24, 28	MSR-M	53112150	15 - 23	.591 - .906	J
40S			MS-SC	53112660	19 - 28	.748 - 1.102	S

# EPIC® Circular Connectors

EAB & EAC Series (5015)

Connector inserts follow standard MIL-C-5015 configurations and are available with either all male or all female contacts.

Shell Size	Insert	No. of Contacts	Voltage Class	Contact Size			Series Offered	Shell Size	Insert	No. of Contacts	Voltage Class	Contact Size			Series Offered
				8	12	16						8	12	16	
10	 10SL-3	3	A			3	EAB Only	20	 20-4	4	D			4	BOTH
	 14S-5	5	Inst			5	EAB Only		 20-27	14	A			14	EAB Only
14	 14S-6	6	Inst			6	EAC Only	 20-29	17	A			17	Both	
	 16S-1	7	A			7	EAC Only	22	 22-22	4	A			4	EAC Only
16	 16-10	3	A			3	EAB Only		24	 24-10	7	A			7
	 18-1	10	A = B, C, F, G Inst = BAL			10	EAC Only	 28-21		37	A				

### Contact Size



16



12



8

# EPIC® Circular Connectors

EAB & EAC Series (5015)

## Wall Mount Receptacle (EA\_00...)

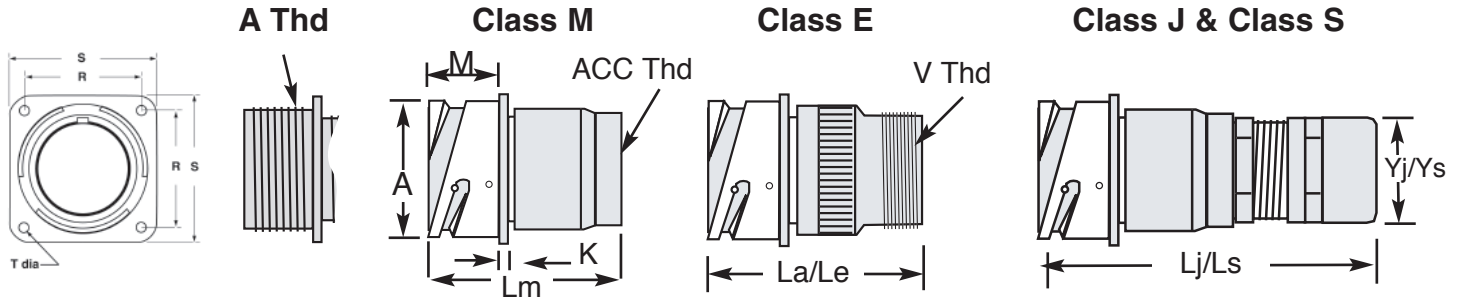

Dimensions in Inches (Millimeters)

Shell Size	A	A Thread Class 2A	K	La/Le Max	Lm Max	Lj/Ls Max	M	R	S	T	Yj/Ys Max	Cable OD Nominal *1	Acc Thread	V Thread Class 2 A
10SL	.717 (18.2)	.625-24 UNEF	.110 (2.8)	1.575 (40)	2.317 (58.85)	3.341 (84.86)	.567 (14.4)	.717 (18.21)	1.000 (25.4)	.126 (3.2)	.894 (22.7)	.177 - .354 (4.5 - 9.0)	M16	5/8-24 UNEF
14S	.969 (24.6)	.875-20 UNEF	.126 (3.2)	1.575 (40)	2.317 (58.85)	3.459 (87.86)	.567 (14.4)	.906 (23.0)	1.181 (30.0)	.126 (3.2)	1.075 (27.3)	.276 - .492 (7.0 - 12.5)	M20	3/4-20 UNEF
16S	1.079 (27.4)	1.000-20 UNEF	.126 (3.2)	1.575 (40)	2.317 (58.85)	3.518 (89.36)	.567 (14.4)	.969 (24.6)	1.280 (32.5)	.126 (3.2)	1.280 (32.5)	.354 - .650 (9.0 - 16.5)	M25	7/8-20 UNEF
16	1.079 (27.4)	1.000-20 UNEF	.126 (3.2)	2.016 (51.2)	2.758 (70.05)	3.959 (100.6)	.756 (19.2)	.969 (24.6)	1.280 (32.5)	.126 (3.2)	1.280 (32.5)	.354 - .650 (9.0 - 16.5)	M25	7/8-20 UNEF
18	1.213 (30.8)	1.125-18 UNEF	.154 (3.9)	2.016 (51.2)	2.758 (70.05)	3.959 (100.6)	.756 (19.2)	1.063 (27.0)	1.378 (35.0)	.126 (3.2)	1.280 (32.5)	.354 - .650 (9.0 - 16.5)	M25	1-20 UNEF
20	1.346 (34.2)	1.250-18 UNEF	.154 (3.9)	2.016 (51.2)	2.953 (75.01)	4.390 (111.5)	.756 (19.2)	1.157 (29.4)	1.496 (38)	.126 (3.2)	1.594 (40.5)	.433 - .827 (11.0 - 21.0)	M32	1 3/16-18 UNEF
22	1.472 (37.4)	1.375-18 UNEF	.154 (3.9)	2.016 (51.2)	2.953 (75.01)	4.390 (111.5)	.756 (19.2)	1.252 (31.8)	1.614 (41)	.126 (3.2)	1.594 (40.5)	.433 - .827 (11.0 - 21.0)	M32	1 3/16-18 UNEF
24	1.610 (40.9)	1.500-18 UNEF	.154 (3.9)	2.067 (52.50)	3.004 (76.30)	4.540 (115.3)	.819 (20.8)	1.374 (34.9)	1.752 (44.5)	.146 (3.7)	2.016 (51.2)	.748 - 1.102 (19.0 - 28.0)	M40	1 7/16-18 UNEF
28	1.839 (46.7)	1.750-18 UNEF	.154 (3.9)	2.382 (60.50)	3.319 (84.30)	4.855 (123.3)	.819 (20.8)	1.563 (39.7)	2.000 (50.8)	.146 (3.7)	2.016 (51.2)	.748 - 1.102 (19.0 - 28.0)	M40	1 7/16-18 UNEF

\*1 For exact OD range see SKINTOP® MS-M (Page 502) or MS-SC-M (Page 505)

## Box Mount Receptacle (EA\_02...)

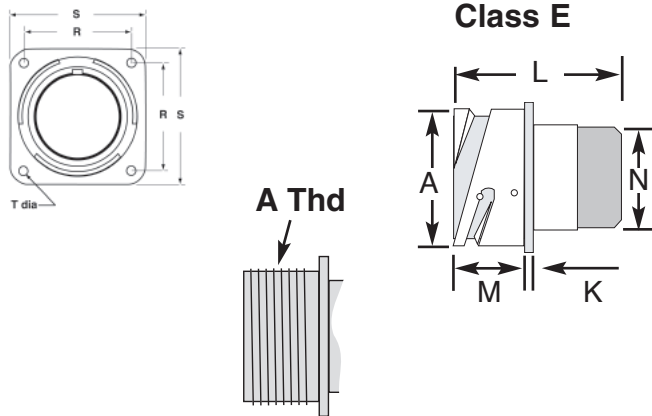

Dimensions in Inches (Millimeters)

Shell Size	A	A Thread	K	L	M	N	R	S	T
10SL	See Table Above	See Table Above	See Table Above	.972 (24.7)	See Table Above	.630 (16.0)	See Table Above	See Table Above	See Table Above
14S				.972 (24.7)		.754 (19.15)			
16S				.972 (24.7)		.880 (22.35)			
16				1.358 (34.5)		.880 (22.35)			
18				1.358 (34.5)		1.008 (25.6)			
20				1.358 (34.5)		1.130 (28.7)			
22				1.358 (34.5)		1.492 (37.9)			
24				1.409 (35.8)		1.382 (35.1)			
28				1.409 (35.8)		1.630 (41.4)			

Application: Wall/box mounting connector. Mates with housing styles EA\_06..., EA\_08...

Note: L\* dimension equals total connector length including cable accessory.

# EPIC® Circular Connectors

EAB & EAC Series (5015)

## Cable Coupler Receptacle (EA\_01...)

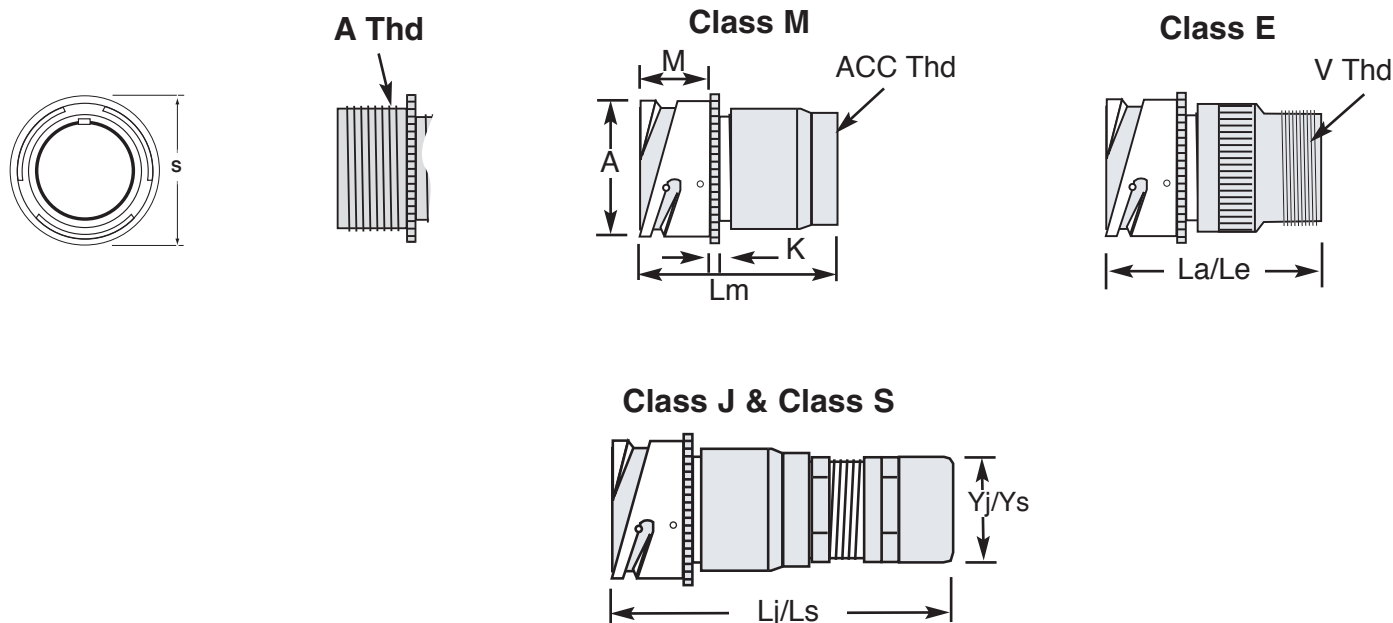

Dimensions in Inches (Millimeters)												
Shell Size	A	A Thread Class 2A	K	La/Le Max	Lm Max	Lj/Ls Max	M	S	Yj/Ys Max	Cable OD Nominal *1	Acc Thread	V Thread Class 2 A
10SL	.717 (18.2)	.625-24 UNEF	.110 (2.8)	1.575 (40)	2.317 (58.85)	3.341 (84.86)	.567 (14.4)	.976 (24.8)	.894 (22.7)	.177 - .354 (4.5 - 9.0)	M16	5/8-24 UNEF
14S	.969 (24.6)	.875-20 UNEF	.126 (3.2)	1.575 (40)	2.317 (58.85)	3.459 (87.86)	.567 (14.4)	1.165 (29.6)	1.075 (27.3)	.276 - .492 (7.0 - 12.5)	M20	3/4-20 UNEF
16S	1.079 (27.4)	1.000-20 UNEF	.126 (3.2)	1.575 (40)	2.317 (58.85)	3.518 (89.36)	.567 (14.4)	1.260 (32.0)	1.280 (32.5)	.354 - .650 (9.0 - 16.5)	M25	7/8-20 UNEF
16	1.079 (27.4)	1.000-20 UNEF	.126 (3.2)	2.016 (51.2)	2.758 (70.05)	3.959 (100.6)	.756 (19.2)	1.260 (32.0)	1.280 (32.5)	.354 - .650 (9.0 - 16.5)	M25	7/8-20 UNEF
18	1.213 (30.8)	1.125-18 UNEF	.154 (3.9)	2.016 (51.2)	2.758 (70.05)	3.959 (100.6)	.756 (19.2)	1.343 (34.1)	1.280 (32.5)	.354 - .650 (9.0 - 16.5)	M25	1-20 UNEF
20	1.346 (34.2)	1.250-18 UNEF	.154 (3.9)	2.016 (51.2)	2.953 (75.01)	4.390 (111.5)	.756 (19.2)	1.500 (38.1)	1.594 (40.5)	.433 - .827 (11.0 - 21.0)	M32	1 3/16-18 UNEF
22	1.472 (37.4)	1.375-18 UNEF	.154 (3.9)	2.016 (51.2)	2.953 (75.01)	4.390 (111.5)	.756 (19.2)	1.622 (41.2)	1.594 (40.5)	.433 - .827 (11.0 - 21.0)	M32	1 3/16-18 UNEF
24	1.610 (40.9)	1.500-18 UNEF	.154 (3.9)	2.067 (52.50)	3.004 (76.30)	4.540 (115.3)	.819 (20.8)	1.764 (44.8)	2.016 (51.2)	.748 - 1.102 (19.0 - 28.0)	M40	1 7/16-18 UNEF
28	1.839 (46.7)	1.750-18 UNEF	.154 (3.9)	2.382 (60.50)	3.319 (84.30)	4.855 (123.3)	.819 (20.8)	2.012 (51.1)	2.016 (51.2)	.748 - 1.102 (19.0 - 28.0)	M40	1 7/16-18 UNEF

\*1 For exact OD range see SKINTOP® MS-M (Page 502) or MS-SC-M (Page 505)

Application: Cable coupler receptacle. Mates with housing styles EA\_06... and EA\_08...

Note: L\* dimension equals total connector length including cable accessory.

# EPIC® Circular Connectors

EAB & EAC Series (5015)

## Straight Plug Connector (EA\_06...)

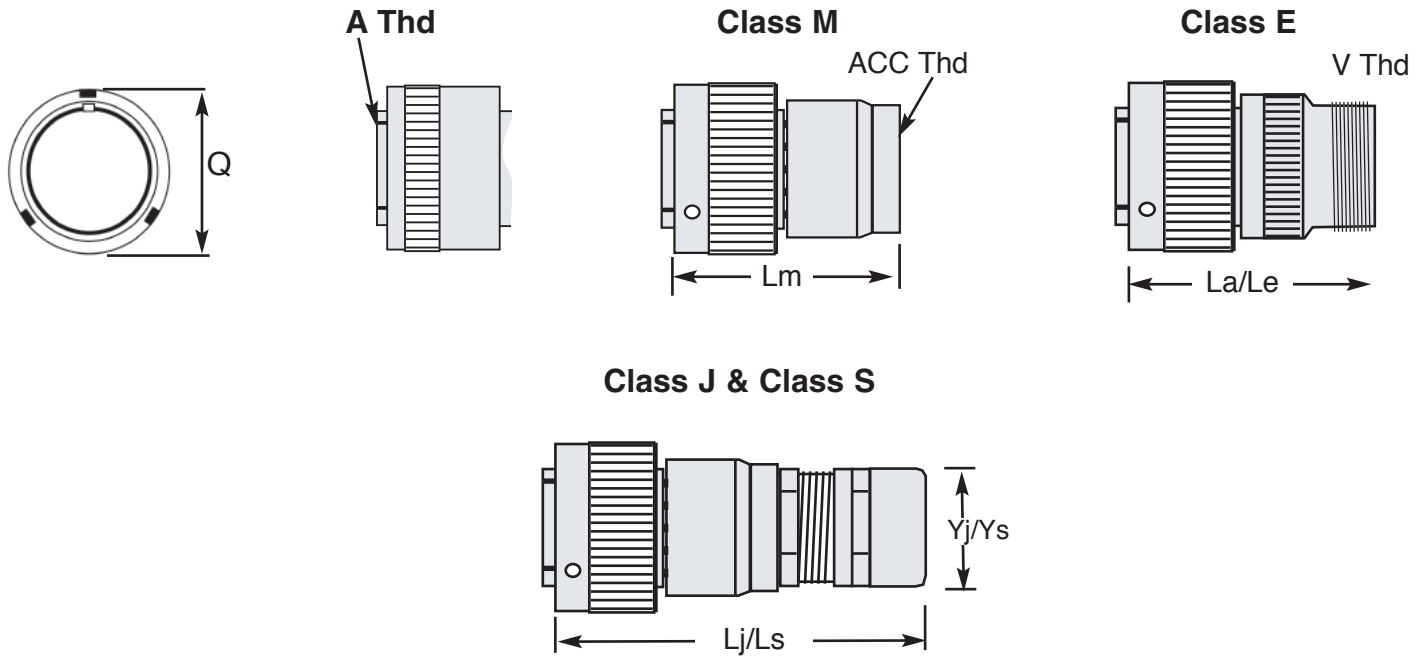

Dimensions in Inches (Millimeters)										
Shell Size	A Thread Class 2A	La/Le Max	Lm Max	Lj/Ls Max	EAB Q	EAC Q	Yj/Ys Max	Cable OD Nominal *1	Acc Thread	V Thread Class 2 A
10SL	.625-24 UNEF	1.575 (40)	2.317 (58.85)	3.341 (84.86)	.866 (22.0)	.906 (23.0)	.894 (22.7)	.177 - .354 (4.5 - 9.0)	M16	5/8-24 UNEF
14S	.875-20 UNEF	1.575 (40)	2.317 (58.85)	3.459 (87.86)	1.142 (29.0)	1.102 (28.0)	1.075 (27.3)	.276 - .492 (7.0 - 12.5)	M20	3/4-20 UNEF
16S	1.000-20 UNEF	1.575 (40)	2.317 (58.85)	3.518 (89.36)	1.252 (31.8)	1.240 (31.5)	1.280 (32.5)	.354 - .650 (9.0 - 16.5)	M25	7/8-20 UNEF
16	1.000-20 UNEF	2.016 (51.2)	2.758 (70.05)	3.959 (100.6)	1.252 (31.8)	1.240 (31.5)	1.280 (32.5)	.354 - .650 (9.0 - 16.5)	M25	7/8-20 UNEF
18	1.125-18 UNEF	2.016 (51.21)	2.758 (70.05)	3.959 (100.6)	1.433 (36.4)	1.343 (34.1)	1.280 (32.5)	.354 - .650 (9.0 - 16.5)	M25	1-20 UNEF
20	1.250-18 UNEF	2.016 (51.21)	2.953 (75.01)	4.390 (111.5)	1.567 (39.8)	1.469 (37.3)	1.594 (40.5)	.433 - .827 (11.0 - 21.0)	M32	1 3/16-18 UNEF
22	1.375-18 UNEF	2.016 (51.21)	2.953 (75.01)	4.390 (111.5)	1.693 (43.0)	1.587 (40.3)	1.594 (40.5)	.433 - .827 (11.0 - 21.0)	M32	1 3/16-18 UNEF
24	1.500-18 UNEF	2.067 (52.50)	3.004 (76.30)	4.540 (115.3)	1.831 (46.5)	1.713 (43.5)	2.016 (51.2)	.748 - 1.102 (19.0 - 28.0)	M40	1 7/16-18 UNEF
28	1.750-18 UNEF	2.382 (60.50)	3.319 (84.30)	4.855 (123.3)	2.067 (52.5)	1.945 (49.4)	2.016 (51.2)	.748 - 1.102 (19.0 - 28.0)	M40	1 7/16-18 UNEF

\*1 For exact OD range see SKINTOP® MS-M (Page 502) or MS-SC-M (Page 505)

Application: Straight plug connector.

Mates with housing styles EA\_00...; EA\_01...; EA\_02...

Note: L\* dimension equals total connector length including cable accessory

# EPIC® Circular Connectors

EAB & EAC Series (5015)

## Right Angle Plug Connector (EA\_08...)

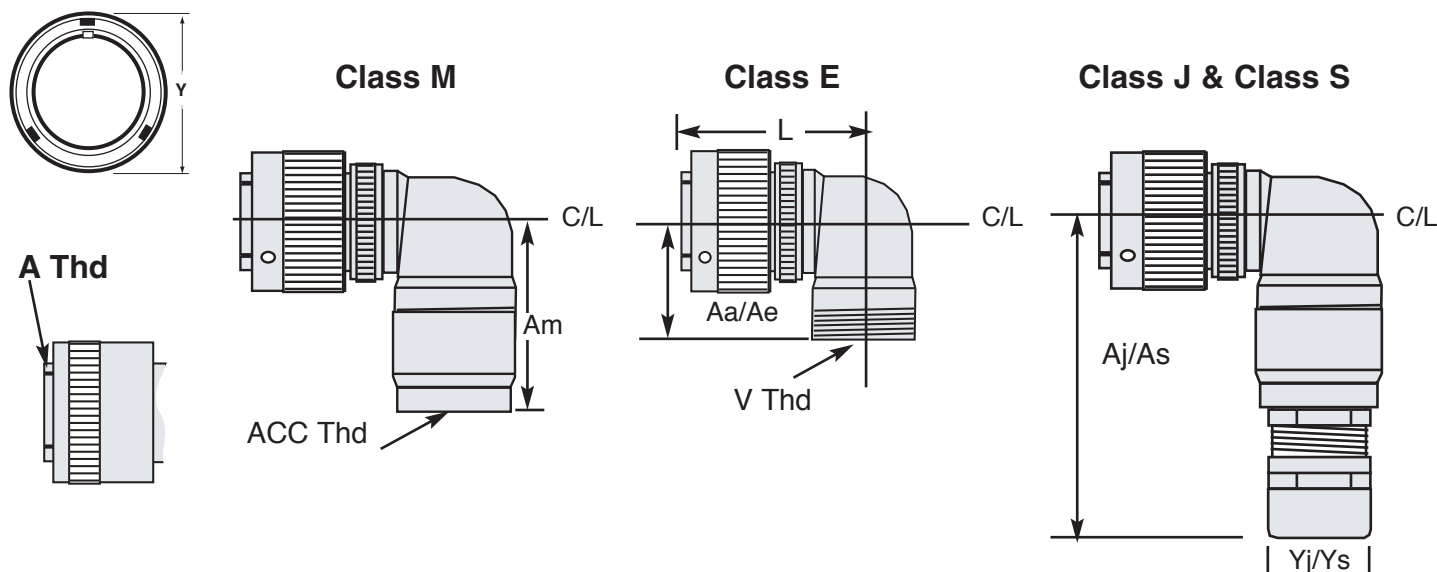

Dimensions in Inches (Millimeters)

Shell Size	A Thread Class 2A	L	Aa/Ae	Am	Aj/As	EAB Y	EAC Y	Yj/Ys Max	Cable OD Nominal *1	Acc Thread	V Thread Class 2 A
10SL	.625-24 UNEF	1.512 (38.4)	.945 (24.0)	2.294 (58.3)	3.318 (84.3)	.894 (22.7)	.906 (23.0)	.894 (22.7)	.177 - .354 (4.5 - 9.0)	M16	5/8-24 UNEF
14S	.875-20 UNEF	1.571 (39.9)	1.031 (26.2)	2.375 (60.3)	3.517 (89.3)	1.142 (29.0)	1.102 (28.0)	1.075 (27.3)	.276 - .492 (7.0 - 12.5)	M20	3/4-20 UNEF
16S	1.000-20 UNEF	1.701 (43.2)	1.094 (27.8)	2.438 (61.9)	3.639 (92.4)	1.252 (31.8)	1.240 (31.5)	1.280 (32.5)	.354 - .650 (9.0 - 16.5)	M25	7/8-20 UNEF
16	1.000-20 UNEF	2.089 (53.1)	1.094 (27.8)	2.493 (63.3)	3.694 (93.8)	1.252 (31.8)	1.240 (31.5)	1.280 (32.5)	.354 - .650 (9.0 - 16.5)	M25	7/8-20 UNEF
18	1.125-18 UNEF	2.195 (55.8)	1.189 (30.2)	2.588 (65.7)	3.789 (96.2)	1.433 (36.4)	1.343 (34.1)	1.280 (32.5)	.354 - .650 (9.0 - 16.5)	M25	1-20 UNEF
20	1.250-18 UNEF	2.315 (58.8)	1.252 (31.8)	NA	NA	1.567 (39.8)	1.469 (37.3)	NA	NA	NA	1 3/16-18 UNEF
22	1.375-18 UNEF	2.417 (61.4)	1.319 (33.5)	NA	NA	1.693 (43.0)	1.587 (40.3)	NA	NA	NA	1 3/16-18 UNEF
24	1.500-18 UNEF	2.465 (62.6)	1.378 (35.0)	NA	NA	1.831 (46.5)	1.713 (43.5)	NA	NA	NA	1 7/16-18 UNEF
28	1.750-18 UNEF	2.555 (64.9)	1.476 (37.5)	NA	NA	2.067 (52.5)	1.965 (49.4)	NA	NA	NA	1 7/16-18 UNEF

\*1 For exact OD range see SKINTOP® MS-M (Page 502) or MS-SC-M (Page 505)

Application: Right angle plug connector.

Mates with housing styles EA\_00...; EA\_01...; and EA\_02...

Note: A\* dimension equals total length from center line including cable accessory

# EPIC® Circular Connectors

EAB & EAC Series (5015)

## Panel Gasket



Shell Size	Flat Panel Gasket
10	61U05315
14	61U05316
16	61U05317
18	61U05318
20	61U05319
22	61U05320
24	61U05321
28	61U05322

## Grommet Hole Seal Plug



Contact Size	Color	Part Number
16	Blue	61U05332
12	Yellow	61U05333
8	White	61U05334

## Crimp Contacts: Spares only- Basic connector includes contact

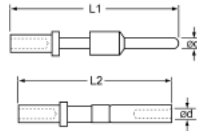

Contact Size	mm <sup>2</sup>	AWG	L1 inches (mm)	L2 inches (mm)	ød inches (mm)	Pin	Socket	Strip Length inch (mm)
16S	1 - 1.5	18 - 16	1.050 (26.7)	1.050 (26.7)	.062 (1.6)	61U05335	61U05339	.312
16	1 - 1.5	18 - 16	1.250 (31.7)	1.440 (36.5)	.062 (1.6)	61U05336	61U05340	(7.9)
12	2.5 - 4.0	14 - 12	1.480 (37.7)	1.480 (37.7)	.093 (2.4)	61U05337	61U05341	
8	10	8	1.660 (42.0)	1.660 (42.0)	.141 (3.6)	61U05338	61U05342	.563 (14.3)

## Connector Dust Caps

### EAB Series

### EAC Series

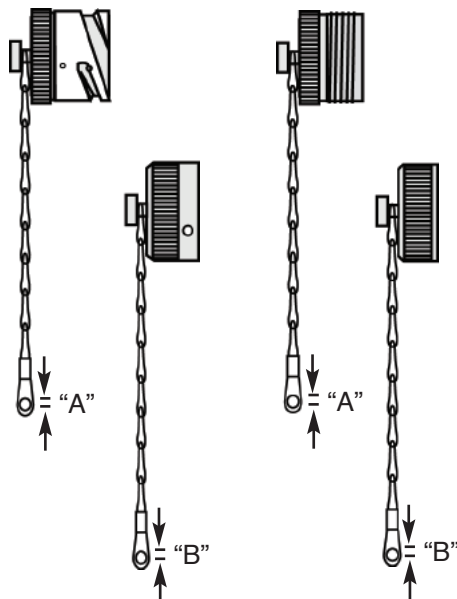

Shell Size	EAB Series	
	Plug Cap*	Receptacle Cap*
10SL	61U05367	61U05359
14S	61U05368	61U05360
16/16S	61U05369	61U05361
18	61U05370	61U05362
20	61U05371	61U05363
22	61U05372	61U05364
24	61U05373	61U05365
28	61U05374	61U05366

Shell Size	EAC Series	
	Plug Cap*	Receptacle Cap*
10SL	61U05351	61U05343
14S	61U05352	61U05344
16/16S	61U05353	61U05345
18	61U05354	61U05346
20	61U05355	61U05347
22	61U05356	61U05348
24	61U05357	61U05349
28	61U05358	61U05350





Shell Size	Chain Hole Diameter	
	Plug Cap "A" in/(mm)	Receptacle Cap "B" in/(mm)
10SL	.157 (4.0)	.142 (3.6)
14S	.157 (4.0)	.142 (3.6)
16/16S	.157 (4.0)	.142 (3.6)
18	.157 (4.0)	.142 (3.6)
20	.189 (4.8)	.142 (3.6)
22	.189 (4.8)	.142 (3.6)
24	.189 (4.8)	.167 (4.25)
28	.189 (4.8)	.167 (4.25)

\*Protective plug caps for use with EA\_06... and EA\_08... connectors

\* Protective receptacle caps for use with EA\_00...; EA\_01...; and EA\_02... connectors

# EPIC® Circular Connectors

EAB & EAC Series (5015)

							
Contact Size	mm <sup>2</sup>	AWG	Crimp Tool	Turret Head	Crimp Gage Go-No Go	Insertion Tool	Removal Tool
16S	1 - 1.5	18 - 16	61U05397	61U05398	61U05399	61U05400	61U05403
16	1 - 1.5	18 - 16				61U05401	61U05404
12	2.5 - 4.0	14 - 12				61U05402	61U05405
8	10	8	*1	*1	*1		

\* Requires pneumatic crimp tool and positioner as manufactured by Pico Crimping Tool Co.

## SKINDICHT® Reducers, Enlargers, and Adapters

For use with Class M connectors

						
Shell Size	Class M Thread	Reducers	Enlargers	Metric to NPT	Metric to PG "A"	Metric to PG "B"
10SL	M16	M16/ M12 52104310	M16/ M20 52104452	M16/ 1/2" 54020100	M16/ PG7 52104200	M16/ PG9 52104340
14S	M20	M20/ M16 52104312	M20/ M25 52104454	M20/ 1/2" 54020110	M20/ PG9 52104210	M20/ PG11 52104360
16S/16	M25	M25/ M20 52104314	M25/M32 52104456	M25/ 3/4" 54020130	M25/ PG16 52104240	M25/PG21 52104400
18						
20	M32	M32/ M25 52104316	M32/ M40 52104458	M32/ 1" 54020152	M32/ PG21 52104260	M32/PG29 52104410
22						
24	M40	M40/ M32 52104318	M40/M50 52104460	M40/ 1 1/4" 54020153	M40/ PG21 52104270	M40/PG36 52104420
28						

# EPIC® Circular Connectors

## EAB & EAC Series (5015)

The EAB and EAC Series connectors are ideal for use with industrial power and control cables. Based on the specific application, a wide variety of cable/connector combinations is possible. The table below provides a sampling of the possibilities.



Application	Power	Control
Stationary/ Flexible	ÖLFLEX® 190/ 190 CY	ÖLFLEX® 190/ 190 CY
	ÖLFLEX® TRAY II/ II CY	ÖLFLEX® TRAY II/ II CY
	ÖLFLEX® POWER IX	ÖLFLEX® CONTROL M
	ÖLFLEX® POWER QUAD II	ÖLFLEX® CONTROL TM
	ÖLFLEX® VFD SLIM	ÖLFLEX® CONTROL COLD
	ÖLFLEX® SERVO 709 CY	ÖLFLEX® AUTO I
	ÖLFLEX® TC 600	ÖLFLEX® TC 600
Continuous Flex	ÖLFLEX® FD 890/ 890 CY	ÖLFLEX® FD 890/ 890 CY
	ÖLFLEX® FD 891/ 891 CY	ÖLFLEX® FD 891/ 891 CY
	ÖLFLEX® FD 890P/ 890 CP	ÖLFLEX® FD 890P/ 890 CP
	ÖLFLEX® FD 891P/ 891 CP	ÖLFLEX® FD 891P/ 891 CP
	ÖLFLEX® FD 890/ 890 CY	ÖLFLEX® FD 890/ 890 CY
	ÖLFLEX® ROBOT 900 P	ÖLFLEX® ROBOT 900 P
		ÖLFLEX® FD AUTO-X

