

HD 40 CRIMP TERMINATED: MACHINE CONTACT INSERTS

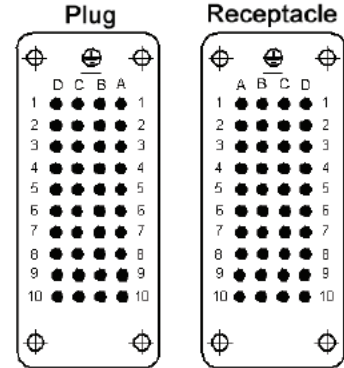

View from cable side

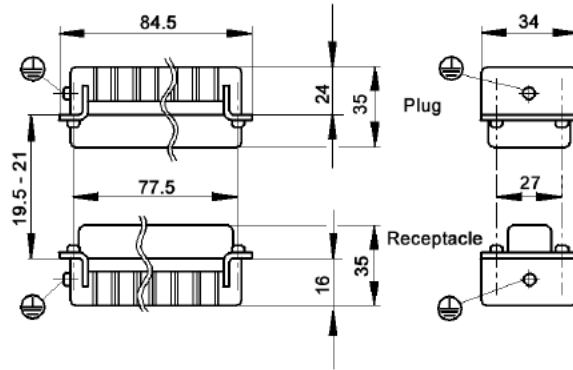

All dimensions are in mm.

Contacts Sold Separately

Plug	Receptacle
11265200	11266200



MACHINE CONTACTS: DIAMETER 1.6 MM

Cross section characteristic

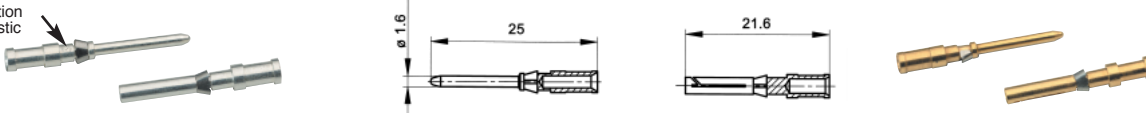

Bags of 100

mm ²	AWG	Silver		Gold		Stripping Length (mm)	# of Marking Tracks
		Pin	Socket	Pin	Socket		
0.14 - 0.37	26 - 22	13162000	13163000	13162500	13163500	8	1
0.5	20	13162100	13163100	13162600	13163600	8	2
0.75 - 1.0	18	13162200	13163200	13162700	13163700	8	3
1.5	16	13162300	13163300	13162800	13163800	8	4
2.5	14	13162400	13163400	13162900	13163900	5.8	5

Part number= 1 contact



Crimp Tool
11147000



Crimp Dies
11147100



Locator
11147200

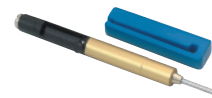

Removal Tool:
11161000

HD 40 CRIMP TERMINATED: STAMPED & FORMED CONTACT INSERTS



Contacts Sold Separately

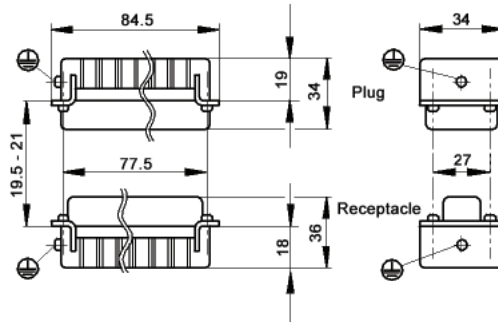

All dimensions are in mm.

View from cable side

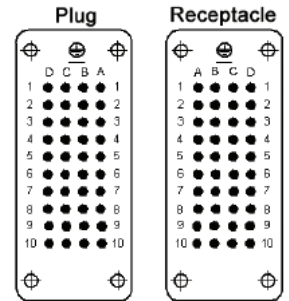

Plug	Receptacle
11265000	11266000

STAMPED & FORMED CONTACTS: DIAMETER 1.6 MM

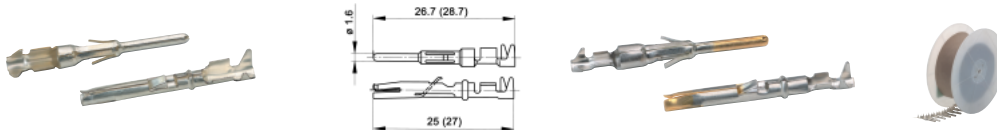

mm ²	Stripping Length (mm)
0.14 - 0.5	2.5 - 0.5
0.5 - 1.5	3.5 - 0.5
1.5 - 2.5	3.5 - 0.5

		Bags of 100: Silver		Bags of 100: Gold		Reel of 100: Silver Left Hand Feed		Reel of 200: Silver Left Hand Feed	
mm ²	AWG	Pin	Socket	Pin	Socket	Pin	Socket	Pin	Socket
0.14 - 0.5	26 - 20	11241100	11231100	11243100	11233100	-	-	11240700	11230700
0.5 - 1.5	20 - 16	11221000	11236100	11221300	11238100	-	-	11220700	11235700
1.5 - 2.5	16 - 14	11223500	11228500	-	-	11223000	11228000	-	-

mm ²	AWG	Reel of 2000: Right Hand Feed- Silver		Reel of 2000: Right Hand Feed- Gold		Reel of 2000: Left Hand Feed- Silver		Reel of 2000: Left Hand Feed- Silver	
		Pin	Socket	Pin	Socket	Pin	Socket	Pin	Socket
0.14 - 0.5	26 - 20	11240000	11230000	-	-	11240400	11230400	11230500	11240500
0.5 - 1.5	20 - 16	11220000	11235000	11220100	11235200	11226000	11226500	-	-
1.5 - 2.5	16 - 14	-	-	-	-	11222700	11227700	-	-

Part number= 1 contact (bags) or 1 reel.



Crimp Tool
11147000



Locator
11147300

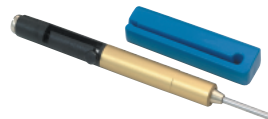

Removal Tool: 11161000



Crimp Tool for Reel:
11153500



Crimp Dies
0.14-0.5: 11147170
0.5-1.5: 11147180
1.5-2.5: 11147190

Crimp Dies for Reel:
0.14-0.5: 11153600
0.5-1.5: 11153700
1.5-2.5: 11153800

