

The HD series inserts are designed for use in industries where large numbers of contacts are required. These crimp inserts are available with stamped and formed or machined contacts. These inserts fit into the HA and HBE Series housings.

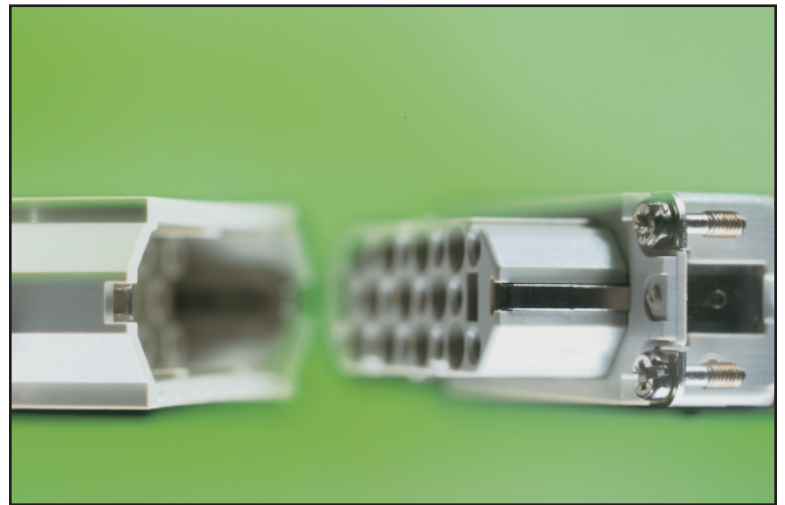

## TECHNICAL DATA

<b>Number of Contacts:</b> 7, 8, 15, 25, 40, 50, 64, 80, 128(+PE)	<b>Termination Type:</b> Crimp termination: 0.14 - 2.5 mm <sup>2</sup> AWG: 22 - 14
<b>Rated Voltage:</b> VDE: 42V (Metal Housing) 250V (Plastic Housing) EPIC HD 7 - 8 250V EPIC HD 15 - 128 UL: 600V EPIC HD 7 - 128	<b>Temperature Range:</b> -40°C to +125°C
<b>Rated Current:</b> VDE: 10A EPIC HD 7 - 128 UL: 10A EPIC HD 7 - 128	<b>Contacts:</b> Copper alloy, silver plated/ gold plated
<b>Pollution Level:</b> 3	<b>Contact Resistance:</b> <2mOhm <3mOhm for HD 40/ 64/ 80/ 128 for Machined Contacts
<b>Test Voltage:</b> 2 kV 2.5 kV for HD 40/ 64/ 80/ 128 for Machined Contacts	<b>Mating Cycles:</b> 100 (higher mating cycles depends on the application)

### HD INSERTS: DERATING CURVES

**HD STAMPED & FORMED:  
0.5 mm<sup>2</sup> (20 AWG)**

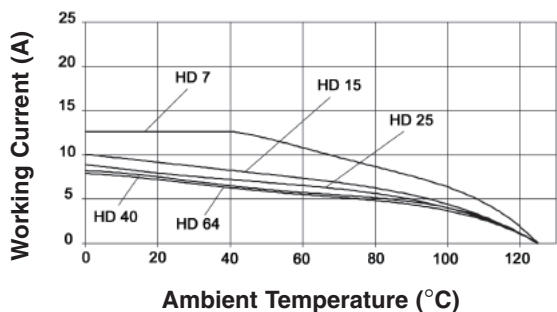

**HD CRIMP MACHINE:  
1.5 mm<sup>2</sup> (16 AWG)**

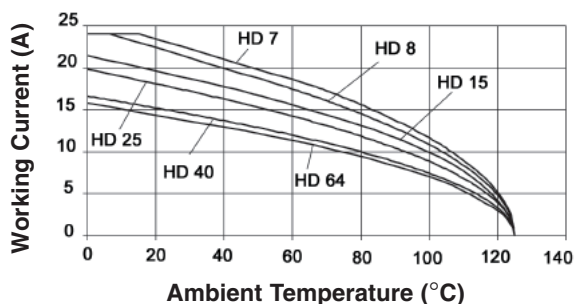

**HD CRIMP MACHINE:  
2.5 mm<sup>2</sup> (14 AWG)**

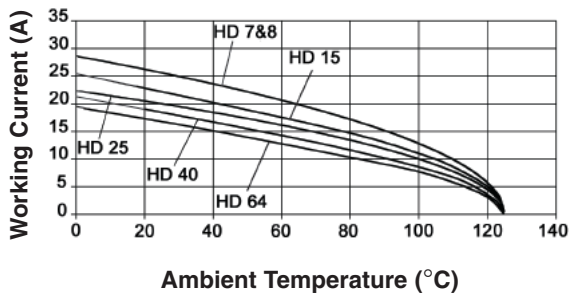

**HD STAMPED & FORMED:  
1.5 mm<sup>2</sup> (16 AWG)**

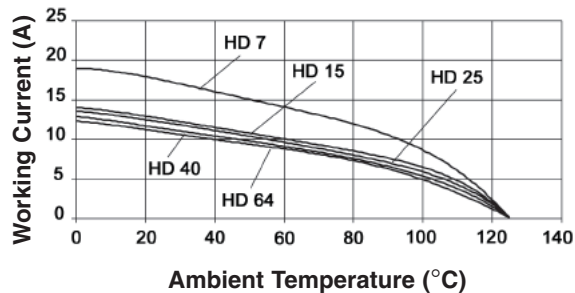

**HD STAMPED & FORMED:  
2.5 mm<sup>2</sup> (14 AWG)**

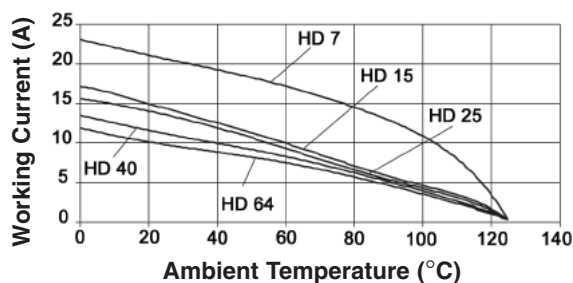

### HD 7 CRIMP TERMINATED: MACHINE CONTACT INSERTS



Contacts Sold Separately



View from Cable Side

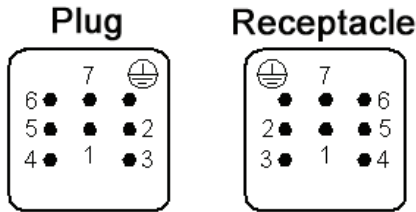

Plug	Receptacle
11250500	11251500

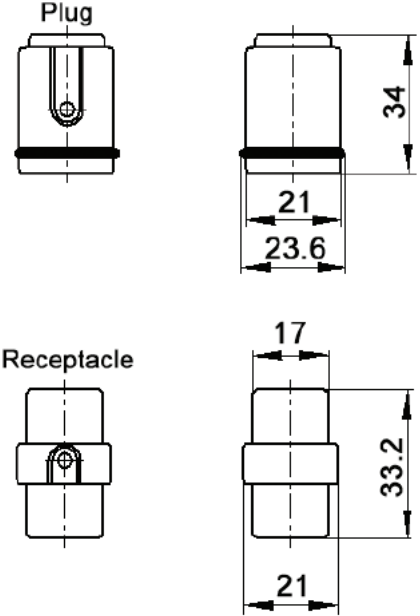

All dimensions are in mm.

### MACHINE CONTACTS: DIAMETER 1.6 MM

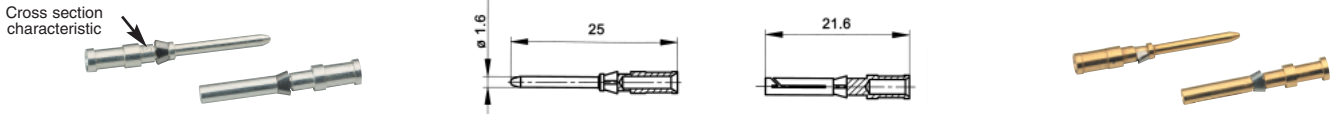

Bags of 100							
mm <sup>2</sup>	AWG	Silver		Gold		Stripping Length (mm)	# of Marking Tracks
		Pin	Socket	Pin	Socket		
0.14 - 0.37	26 - 22	13162000	13163000	13162500	13163500	8	1
0.5	20	13162100	13163100	13162600	13163600	8	2
0.75 - 1.0	18	13162200	13163200	13162700	13163700	8	3
1.5	16	13162300	13163300	13162800	13163800	8	4
2.5	14	13162400	13163400	13162900	13163900	5.8	5

Part number= 1 contact



Crimp Tool  
11147000



Crimp Dies  
11147100



Locator  
11147200

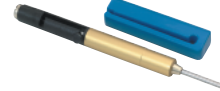

Removal Tool:  
11161000

### FIBER OPTIC CONTACTS & TOOLS



Pin	Socket
11214100	11219100

Fiber Optic Assembly Set
11184700



### HD 7 CRIMP TERMINATED: STAMPED & FORMED CONTACT INSERTS



Coding Pin: 11162000  
Removal Tool: 11161200

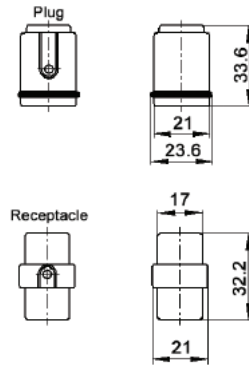

View from Cable Side

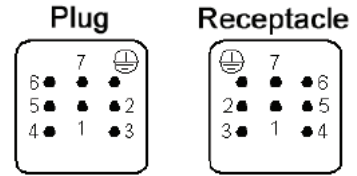

All dimensions are in mm.

Contacts Sold Separately

Plug	Receptacle
11250000	11251000



### STAMPED & FORMED CONTACTS: DIAMETER 1.6 MM

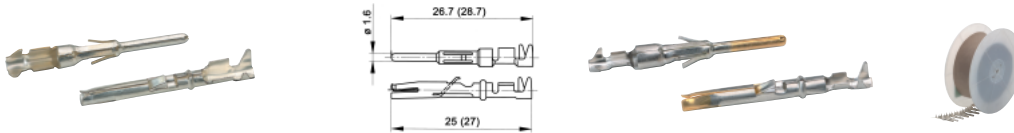

mm <sup>2</sup>	Stripping Length (mm)
0.14 - 0.5	2.5 - 0.5
0.5 - 1.5	3.5 - 0.5
1.5 - 2.5	3.5 - 0.5

		Bags of 100: Silver		Bags of 100: Gold		Reel of 100: Silver Left Hand Feed		Reel of 200: Silver Left Hand Feed	
mm <sup>2</sup>	AWG	Pin	Socket	Pin	Socket	Pin	Socket	Pin	Socket
0.14 - 0.5	26 - 20	11241100	11231100	11243100	11233100	-	-	11240700	11230700
0.5 - 1.5	20 - 16	11221000	11236100	11221300	11238100	-	-	11220700	11235700
1.5 - 2.5	16 - 14	11223500	11228500	-	-	11223000	11228000	-	-

mm <sup>2</sup>	AWG	Reel of 2000: Right Hand Feed- Silver		Reel of 2000: Right Hand Feed- Gold		Reel of 2000: Left Hand Feed- Silver		Reel of 2000: Left Hand Feed- Silver	
		Pin	Socket	Pin	Socket	Pin	Socket	Pin	Socket
0.14 - 0.5	26 - 20	11240000	11230000	-	-	11240400	11230400	11230500	11240500
0.5 - 1.5	20 - 16	11220000	11235000	11220100	11235200	11226000	11226500	-	-
1.5 - 2.5	16 - 14	-	-	-	-	11222700	11227700	-	-

Part number= 1 contact (bags) or 1 reel.



Crimp Tool  
11147000



Locator  
11147300

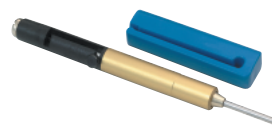

Removal Tool: 11161000



Crimp Tool for Reel:  
11153500



Crimp Dies  
0.14-0.5: 11147170  
0.5-1.5: 11147180  
1.5-2.5: 11147190

Crimp Dies for Reel:  
0.14-0.5: 11153600  
0.5-1.5: 11153700  
1.5-2.5: 11153800



### HD 8 CRIMP TERMINATED: MACHINE CONTACT INSERTS



View from Cable Side

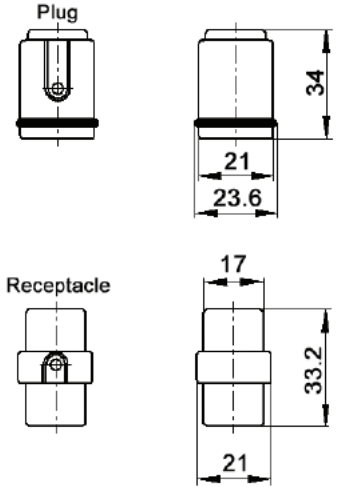
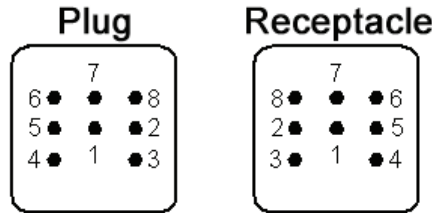

All dimensions are in mm.

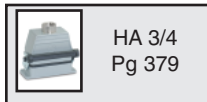

Plug	Receptacle
11252500	11253500

Contacts Sold Separately

### MACHINE CONTACTS: DIAMETER 1.6 MM

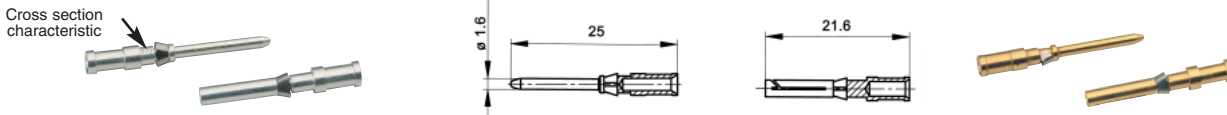

Bags of 100							
mm <sup>2</sup>	AWG	Silver		Gold		Stripping Length (mm)	# of Marking Tracks
		Pin	Socket	Pin	Socket		
0.14 - 0.37	26 - 22	13162000	13163000	13162500	13163500	8	1
0.5	20	13162100	13163100	13162600	13163600	8	2
0.75 - 1.0	18	13162200	13163200	13162700	13163700	8	3
1.5	16	13162300	13163300	13162800	13163800	8	4
2.5	14	13162400	13163400	13162900	13163900	5.8	5

Part number= 1 contact



**Crimp Tool**  
11147000



**Crimp Dies**  
11147100



**Locator**  
11147200

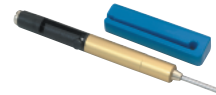

**Removal Tool:**  
11161000

### FIBER OPTIC CONTACTS & TOOLS



Pin	Socket
11214100	11219100

Fiber Optic Assembly Set
11184700



### HD 15 CRIMP TERMINATED: MACHINE CONTACT INSERTS

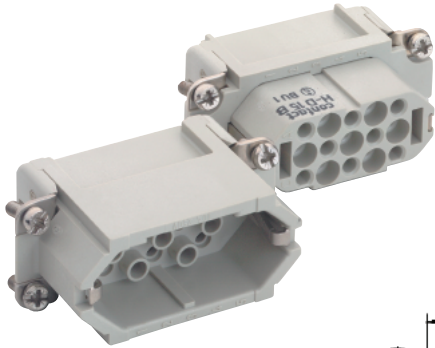

View from cable side

Plug

Receptacle

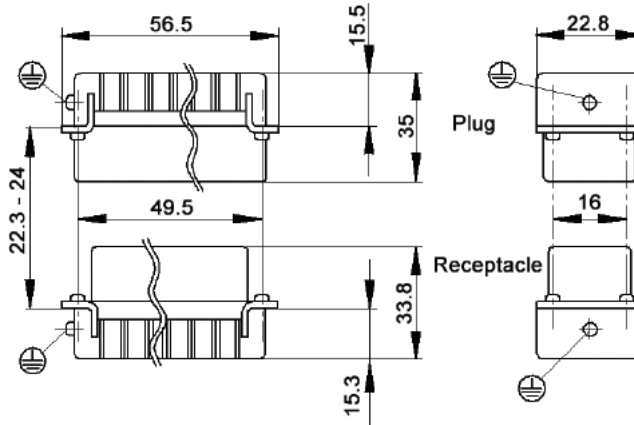
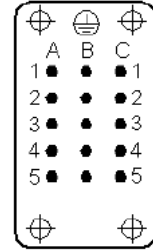
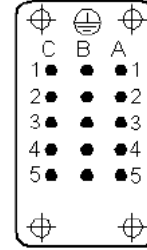

All dimensions are in mm.

Contacts Sold Separately

Plug	Receptacle
11283200	11282200



### MACHINE CONTACTS: DIAMETER 1.6 MM

Cross section characteristic

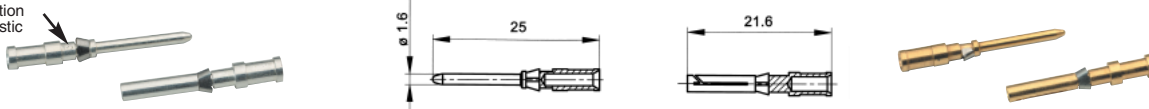

Bags of 100

mm <sup>2</sup>	AWG	Silver		Gold		Stripping Length (mm)	# of Marking Tracks
		Pin	Socket	Pin	Socket		
0.14 - 0.37	26 - 22	13162000	13163000	13162500	13163500	8	1
0.5	20	13162100	13163100	13162600	13163600	8	2
0.75 - 1.0	18	13162200	13163200	13162700	13163700	8	3
1.5	16	13162300	13163300	13162800	13163800	8	4
2.5	14	13162400	13163400	13162900	13163900	5.8	5

Part number= 1 contact



**Crimp Tool**  
11147000



**Crimp Dies**  
11147100



**Locator**  
11147200

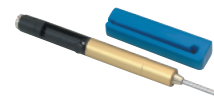

**Removal Tool:**  
11161000

### HD 15 CRIMP TERMINATED: STAMPED & FORMED CONTACT INSERTS

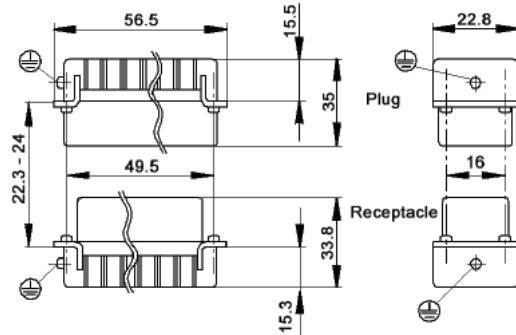
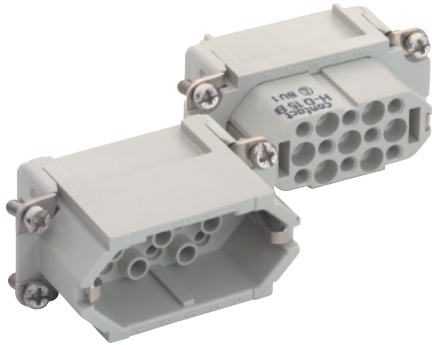

All dimensions are in mm.

Contacts Sold Separately

Plug	Receptacle
11255000	11256000



### STAMPED & FORMED CONTACTS: DIAMETER 1.6 MM

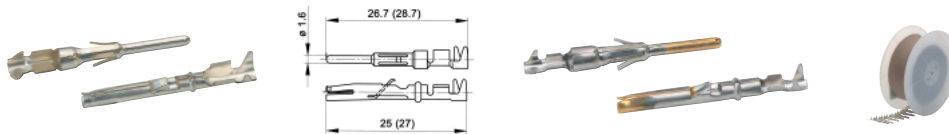

mm <sup>2</sup>	Stripping Length (mm)
0.14 - 0.5	2.5 - 0.5
0.5 - 1.5	3.5 - 0.5
1.5 - 2.5	3.5 - 0.5

		Bags of 100: Silver		Bags of 100: Gold		Reel of 100: Silver Left Hand Feed		Reel of 200: Silver Left Hand Feed	
mm <sup>2</sup>	AWG	Pin	Socket	Pin	Socket	Pin	Socket	Pin	Socket
0.14 - 0.5	26 - 20	11241100	11231100	11243100	11233100	-	-	11240700	11230700
0.5 - 1.5	20 - 16	11221000	11236100	11221300	11238100	-	-	11220700	11235700
1.5 - 2.5	16 - 14	11223500	11228500	-	-	11223000	11228000	-	-

mm <sup>2</sup>	AWG	Reel of 2000: Right Hand Feed- Silver		Reel of 2000: Right Hand Feed- Gold		Reel of 2000: Left Hand Feed- Silver		Reel of 2000: Left Hand Feed- Silver	
		Pin	Socket	Pin	Socket	Pin	Socket	Pin	Socket
0.14 - 0.5	26 - 20	11240000	11230000	-	-	11240400	11230400	11230500	11240500
0.5 - 1.5	20 - 16	11220000	11235000	11220100	11235200	11226000	11226500	-	-
1.5 - 2.5	16 - 14	-	-	-	-	11222700	11227700	-	-

Part number= 1 contact (bags) or 1 reel.



**Crimp Tool**  
11147000



**Locator**  
11147300

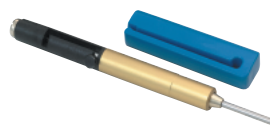

**Removal Tool:** 11161000



**Crimp Tool for Reel:**  
11153500



**Crimp Dies**

0.14-0.5:	11147170
0.5-1.5:	11147180
1.5-2.5:	11147190

**Crimp Dies for Reel:**

0.14-0.5:	11153600
0.5-1.5:	11153700
1.5-2.5:	11153800



### HD 25 CRIMP TERMINATED: MACHINE CONTACT INSERTS

View from cable side

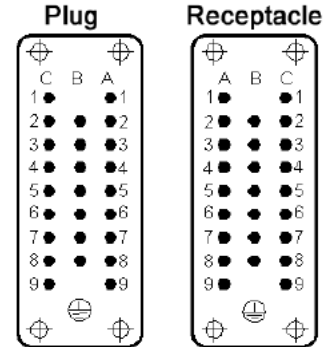
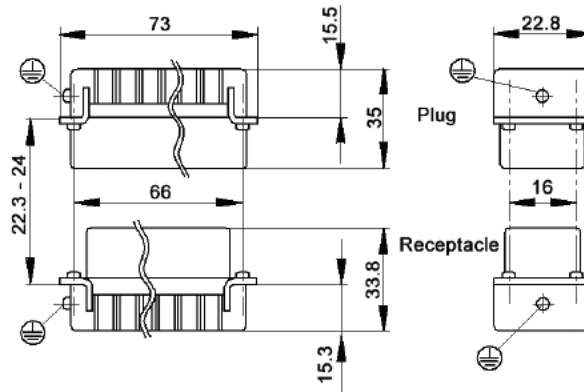

All dimensions are in mm.

Contacts Sold Separately

Plug	Receptacle
11283300	11282300

### MACHINE CONTACTS: DIAMETER 1.6 MM

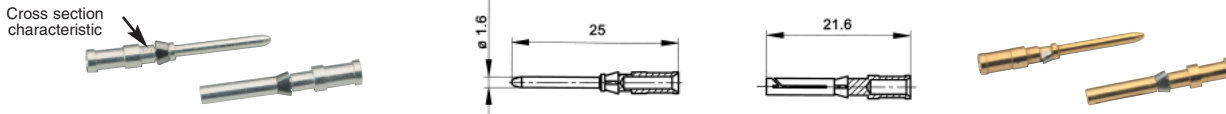

Bags of 100							
mm <sup>2</sup>	AWG	Silver		Gold		Stripping Length (mm)	# of Marking Tracks
		Pin	Socket	Pin	Socket		
0.14 - 0.37	26 - 22	13162000	13163000	13162500	13163500	8	1
0.5	20	13162100	13163100	13162600	13163600	8	2
0.75 - 1.0	18	13162200	13163200	13162700	13163700	8	3
1.5	16	13162300	13163300	13162800	13163800	8	4
2.5	14	13162400	13163400	13162900	13163900	5.8	5

Part number= 1 contact



**Crimp Tool**  
11147000



**Crimp Dies**  
11147100



**Locator**  
11147200

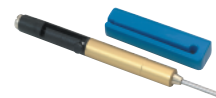

**Removal Tool:**  
11161000

### HD 25 CRIMP TERMINATED: STAMPED & FORMED CONTACT INSERTS

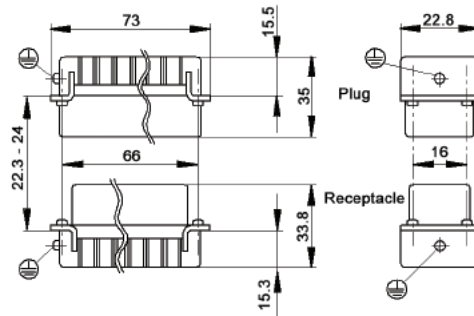

View from cable side

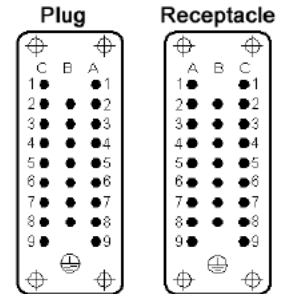

All dimensions are in mm.

Contacts Sold Separately

Plug	Receptacle
11260000	11261000



### STAMPED & FORMED CONTACTS: DIAMETER 1.6 MM

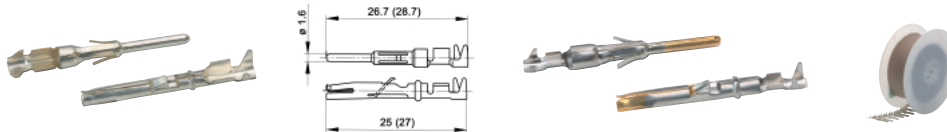

mm <sup>2</sup>	Stripping Length (mm)
0.14 - 0.5	2.5 - 0.5
0.5 - 1.5	3.5 - 0.5
1.5 - 2.5	3.5 - 0.5

		Bags of 100: Silver		Bags of 100: Gold		Reel of 100: Silver Left Hand Feed		Reel of 200: Silver Left Hand Feed	
mm <sup>2</sup>	AWG	Pin	Socket	Pin	Socket	Pin	Socket	Pin	Socket
0.14 - 0.5	26 - 20	11241100	11231100	11243100	11233100	-	-	11240700	11230700
0.5 - 1.5	20 - 16	11221000	11236100	11221300	11238100	-	-	11220700	11235700
1.5 - 2.5	16 - 14	11223500	11228500	-	-	11223000	11228000	-	-

mm <sup>2</sup>	AWG	Reel of 2000: Right Hand Feed- Silver		Reel of 2000: Right Hand Feed- Gold		Reel of 2000: Left Hand Feed- Silver		Reel of 2000: Left Hand Feed- Silver	
		Pin	Socket	Pin	Socket	Pin	Socket	Pin	Socket
0.14 - 0.5	26 - 20	11240000	11230000	-	-	11240400	11230400	11230500	11240500
0.5 - 1.5	20 - 16	11220000	11235000	11220100	11235200	11226000	11226500	-	-
1.5 - 2.5	16 - 14	-	-	-	-	11222700	11227700	-	-

Part number= 1 contact (bags) or 1 reel.



**Crimp Tool**  
11147000



**Locator**  
11147300

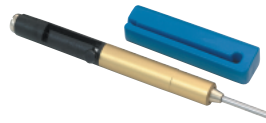

**Removal Tool: 11161000**



**Crimp Tool for Reel:**  
11153500



**Crimp Dies**  
0.14-0.5: 11147170  
0.5-1.5: 11147180  
1.5-2.5: 11147190

**Crimp Dies for Reel:**  
0.14-0.5: 11153600  
0.5-1.5: 11153700  
1.5-2.5: 11153800

### HD 40 CRIMP TERMINATED: MACHINE CONTACT INSERTS



View from cable side

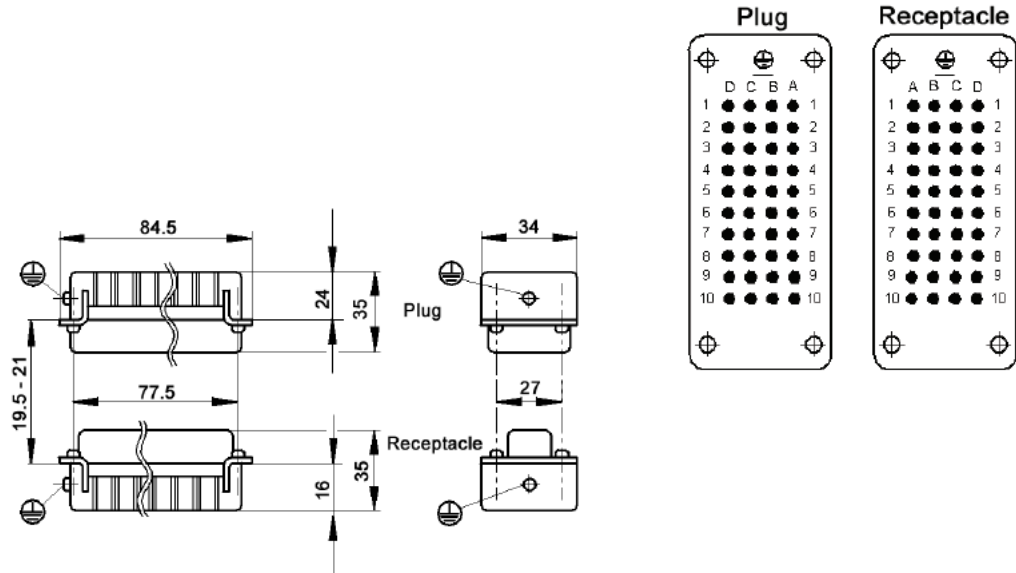

All dimensions are in mm.

Contacts Sold Separately

Plug	Receptacle
11265200	11266200



### MACHINE CONTACTS: DIAMETER 1.6 MM

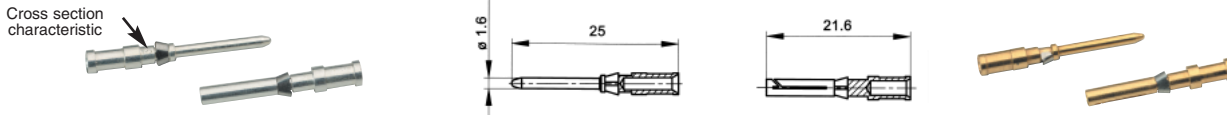

Bags of 100							
mm <sup>2</sup>	AWG	Silver		Gold		Stripping Length (mm)	# of Marking Tracks
		Pin	Socket	Pin	Socket		
0.14 - 0.37	26 - 22	13162000	13163000	13162500	13163500	8	1
0.5	20	13162100	13163100	13162600	13163600	8	2
0.75 - 1.0	18	13162200	13163200	13162700	13163700	8	3
1.5	16	13162300	13163300	13162800	13163800	8	4
2.5	14	13162400	13163400	13162900	13163900	5.8	5

Part number= 1 contact



**Crimp Tool**  
11147000



**Crimp Dies**  
11147100



**Locator**  
11147200

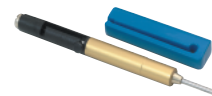

**Removal Tool:**  
11161000

# EPIC® Rectangular Connectors



HD Series

## HD 40 CRIMP TERMINATED: STAMPED & FORMED CONTACT INSERTS

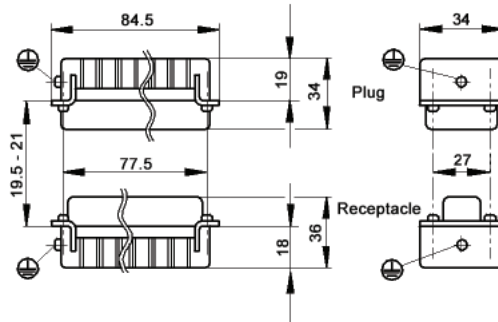

View from cable side

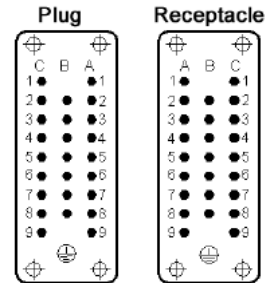

All dimensions are in mm.

Contacts Sold Separately

Plug	Receptacle
11265000	11266000



## STAMPED & FORMED CONTACTS: DIAMETER 1.6 MM

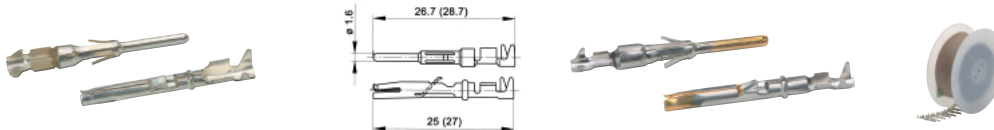

mm <sup>2</sup>	Stripping Length (mm)
0.14 - 0.5	2.5 - 0.5
0.5 - 1.5	3.5 - 0.5
1.5 - 2.5	3.5 - 0.5

		Bags of 100: Silver		Bags of 100: Gold		Reel of 100: Silver Left Hand Feed		Reel of 200: Silver Left Hand Feed	
mm <sup>2</sup>	AWG	Pin	Socket	Pin	Socket	Pin	Socket	Pin	Socket
0.14 - 0.5	26 - 20	11241100	11231100	11243100	11233100	-	-	11240700	11230700
0.5 - 1.5	20 - 16	11221000	11236100	11221300	11238100	-	-	11220700	11235700
1.5 - 2.5	16 - 14	11223500	11228500	-	-	11223000	11228000	-	-

mm <sup>2</sup>	AWG	Reel of 2000: Right Hand Feed- Silver		Reel of 2000: Right Hand Feed- Gold		Reel of 2000: Left Hand Feed- Silver		Reel of 2000: Left Hand Feed- Silver	
		Pin	Socket	Pin	Socket	Pin	Socket	Pin	Socket
0.14 - 0.5	26 - 20	11240000	11230000	-	-	11240400	11230400	11230500	11240500
0.5 - 1.5	20 - 16	11220000	11235000	11220100	11235200	11226000	11226500	-	-
1.5 - 2.5	16 - 14	-	-	-	-	11222700	11227700	-	-

Part number= 1 contact (bags) or 1 reel.



**Crimp Tool**  
11147000



**Locator**  
11147300

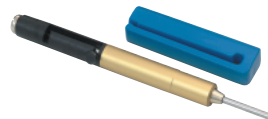

**Removal Tool:** 11161000



**Crimp Tool for Reel:**  
11153500



**Crimp Dies**

0.14-0.5:	11147170
0.5-1.5:	11147180
1.5-2.5:	11147190

**Crimp Dies for Reel:**

0.14-0.5:	11153600
0.5-1.5:	11153700
1.5-2.5:	11153800



### HD 50 CRIMP TERMINATED: MACHINE CONTACT INSERTS

View from cable side



Plugs

Receptacles

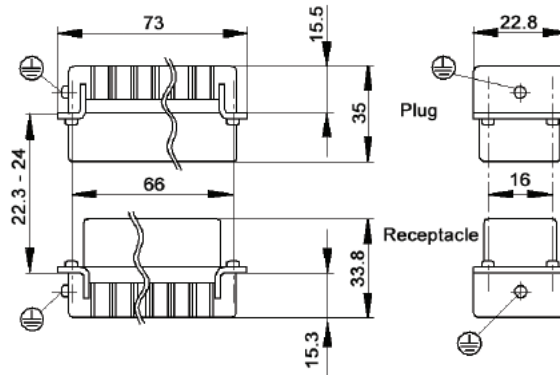
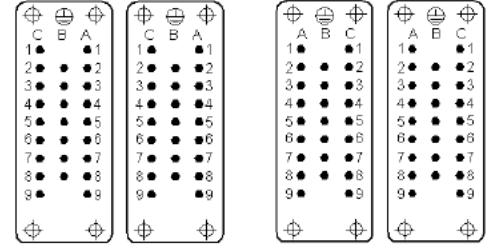

All dimensions are in mm.

Contacts Sold Separately

Plug	Receptacle
11260200 (2X)	11261200 (2X)



### MACHINE CONTACTS: DIAMETER 1.6 MM

Cross section characteristic

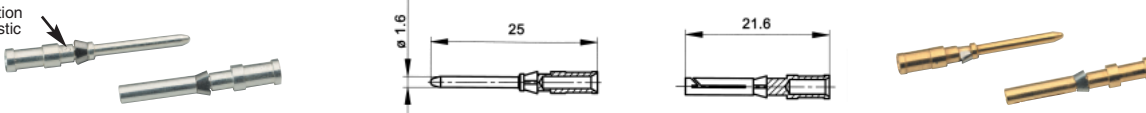

Bags of 100

mm <sup>2</sup>	AWG	Silver		Gold		Stripping Length (mm)	# of Marking Tracks
		Pin	Socket	Pin	Socket		
0.14 - 0.37	26 - 22	13162000	13163000	13162500	13163500	8	1
0.5	20	13162100	13163100	13162600	13163600	8	2
0.75 - 1.0	18	13162200	13163200	13162700	13163700	8	3
1.5	16	13162300	13163300	13162800	13163800	8	4
2.5	14	13162400	13163400	13162900	13163900	5.8	5

Part number= 1 contact



Crimp Tool  
11147000



Crimp Dies  
11147100



Locator  
11147200

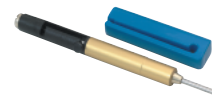

Removal Tool:  
11161000

### HD 50 CRIMP TERMINATED: STAMPED & FORMED CONTACT INSERTS

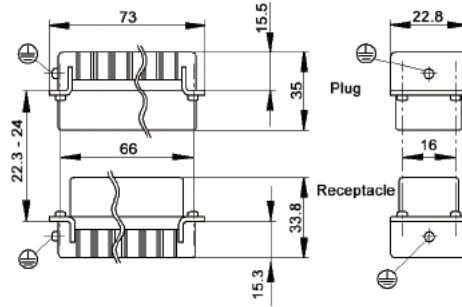

View from cable side

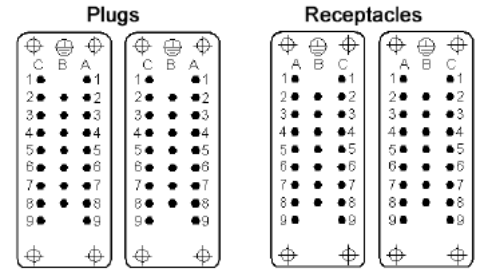

All dimensions are in mm.

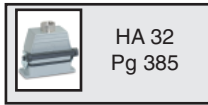

Plug	Receptacle
11260000 (2X)	11261000 (2X)

Contacts Sold Separately

### STAMPED & FORMED CONTACTS: DIAMETER 1.6 MM

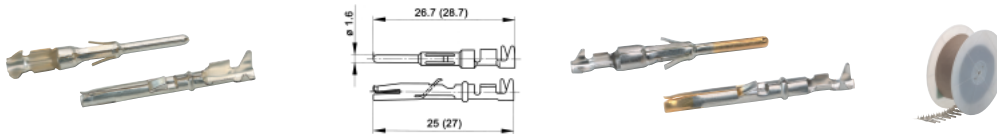

mm <sup>2</sup>	Stripping Length (mm)
0.14 - 0.5	2.5 - 0.5
0.5 - 1.5	3.5 - 0.5
1.5 - 2.5	3.5 - 0.5

		Bags of 100: Silver		Bags of 100: Gold		Reel of 100: Silver Left Hand Feed		Reel of 200: Silver Left Hand Feed	
mm <sup>2</sup>	AWG	Pin	Socket	Pin	Socket	Pin	Socket	Pin	Socket
0.14 - 0.5	26 - 20	11241100	11231100	11243100	11233100	-	-	11240700	11230700
0.5 - 1.5	20 - 16	11221000	11236100	11221300	11238100	-	-	11220700	11235700
1.5 - 2.5	16 - 14	11223500	11228500	-	-	11223000	11228000	-	-

mm <sup>2</sup>	AWG	Reel of 2000: Right Hand Feed- Silver		Reel of 2000: Right Hand Feed- Gold		Reel of 2000: Left Hand Feed- Silver		Reel of 2000: Left Hand Feed- Silver	
		Pin	Socket	Pin	Socket	Pin	Socket	Pin	Socket
0.14 - 0.5	26 - 20	11240000	11230000	-	-	11240400	11230400	11230500	11240500
0.5 - 1.5	20 - 16	11220000	11235000	11220100	11235200	11226000	11226500	-	-
1.5 - 2.5	16 - 14	-	-	-	-	11222700	11227700	-	-

Part number= 1 contact (bags) or 1 reel.



**Crimp Tool**  
11147000



**Locator**  
11147300

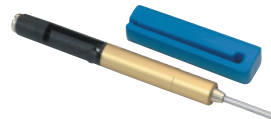

**Removal Tool:** 11161000



**Crimp Tool for Reel:**  
11153500



**Crimp Dies**  
0.14-0.5: 11147170  
0.5-1.5: 11147180  
1.5-2.5: 11147190

**Crimp Dies for Reel:**  
0.14-0.5: 11153600  
0.5-1.5: 11153700  
1.5-2.5: 11153800



### HD 64 CRIMP TERMINATED: MACHINE CONTACT INSERTS

View from cable side

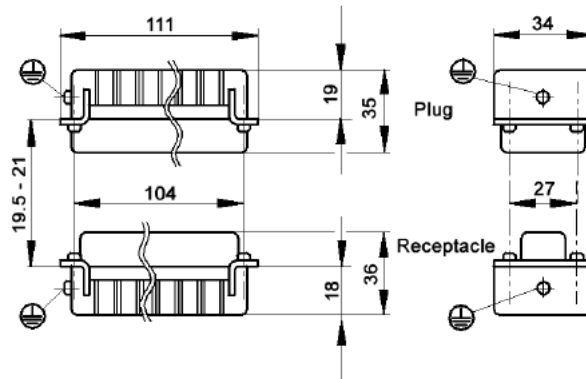
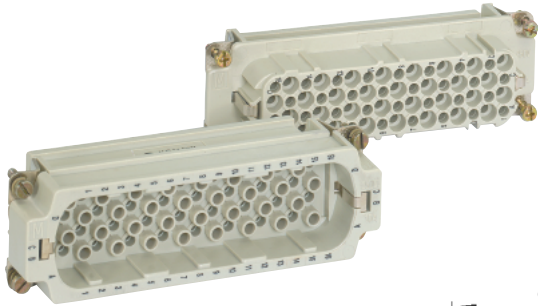

All dimensions are in mm.

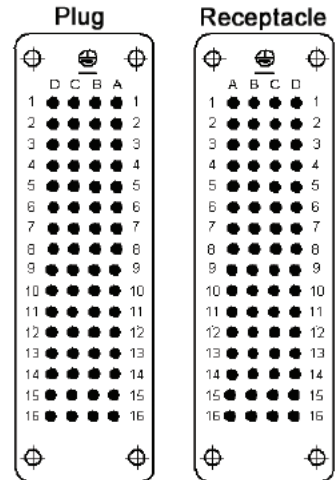

Contacts Sold Separately

Plug	Receptacle
11272000	11273000



### MACHINE CONTACTS: DIAMETER 1.6 MM

Cross section characteristic

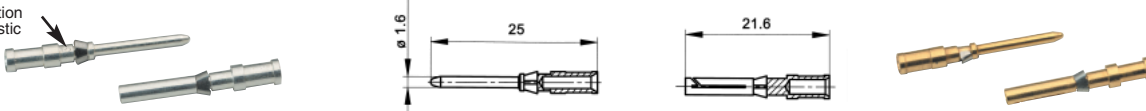

Bags of 100

mm <sup>2</sup>	AWG	Silver		Gold		Stripping Length (mm)	# of Marking Tracks
		Pin	Socket	Pin	Socket		
0.14 - 0.37	26 - 22	13162000	13163000	13162500	13163500	8	1
0.5	20	13162100	13163100	13162600	13163600	8	2
0.75 - 1.0	18	13162200	13163200	13162700	13163700	8	3
1.5	16	13162300	13163300	13162800	13163800	8	4
2.5	14	13162400	13163400	13162900	13163900	5.8	5

Part number= 1 contact



**Crimp Tool**  
11147000



**Crimp Dies**  
11147100



**Locator**  
11147200

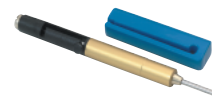

**Removal Tool:**  
11161000

# EPIC® Rectangular Connectors

HD Series



## HD 64 CRIMP TERMINATED: STAMPED & FORMED CONTACT INSERTS

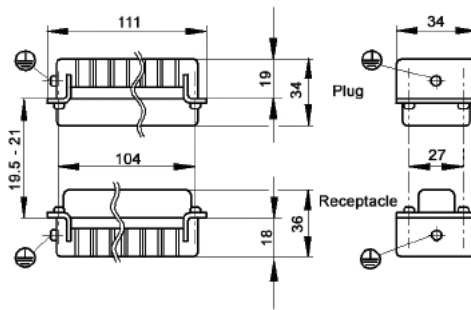
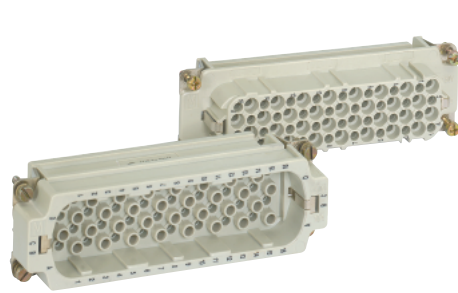

All dimensions are in mm.

View from cable side

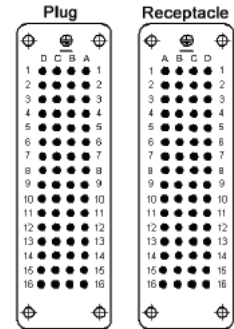

Contacts Sold Separately

Plug	Receptacle
11270000	11271000



## STAMPED & FORMED CONTACTS: DIAMETER 1.6 MM

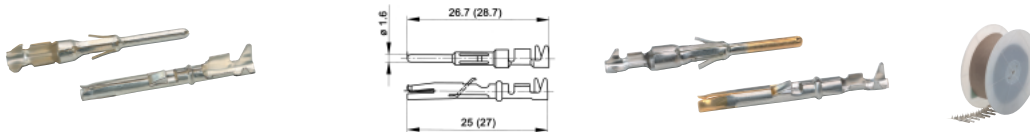

mm <sup>2</sup>	Stripping Length (mm)
0.14 - 0.5	2.5 - 0.5
0.5 - 1.5	3.5 - 0.5
1.5 - 2.5	3.5 - 0.5

		Bags of 100: Silver		Bags of 100: Gold		Reel of 100: Silver Left Hand Feed		Reel of 200: Silver Left Hand Feed	
mm <sup>2</sup>	AWG	Pin	Socket	Pin	Socket	Pin	Socket	Pin	Socket
0.14 - 0.5	26 - 20	11241100	11231100	11243100	11233100	-	-	11240700	11230700
0.5 - 1.5	20 - 16	11221000	11236100	11221300	11238100	-	-	11220700	11235700
1.5 - 2.5	16 - 14	11223500	11228500	-	-	11223000	11228000	-	-

mm <sup>2</sup>	AWG	Reel of 2000: Right Hand Feed- Silver		Reel of 2000: Right Hand Feed- Gold		Reel of 2000: Left Hand Feed- Silver		Reel of 2000: Left Hand Feed- Silver	
		Pin	Socket	Pin	Socket	Pin	Socket	Pin	Socket
0.14 - 0.5	26 - 20	11240000	11230000	-	-	11240400	11230400	11230500	11240500
0.5 - 1.5	20 - 16	11220000	11235000	11220100	11235200	11226000	11226500	-	-
1.5 - 2.5	16 - 14	-	-	-	-	11222700	11227700	-	-

Part number= 1 contact (bags) or 1 reel.



**Crimp Tool**  
11147000



**Locator**  
11147300

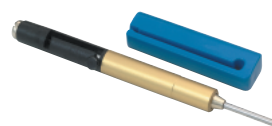

**Removal Tool: 11161000**



**Crimp Tool for Reel:**  
11153500



**Crimp Dies**

0.14-0.5:	11147170
0.5-1.5:	11147180
1.5-2.5:	11147190

**Crimp Dies for Reel:**

0.14-0.5:	11153600
0.5-1.5:	11153700
1.5-2.5:	11153800

### HD 80 CRIMP TERMINATED: MACHINE CONTACT INSERTS

View from cable side

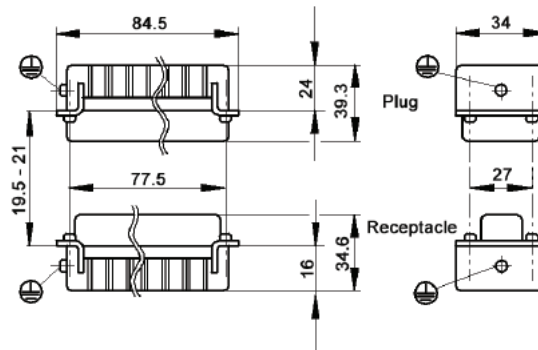
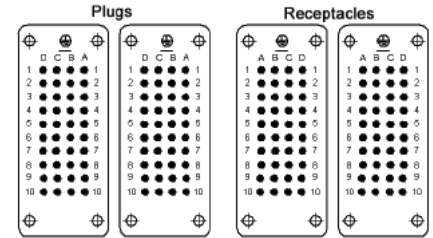
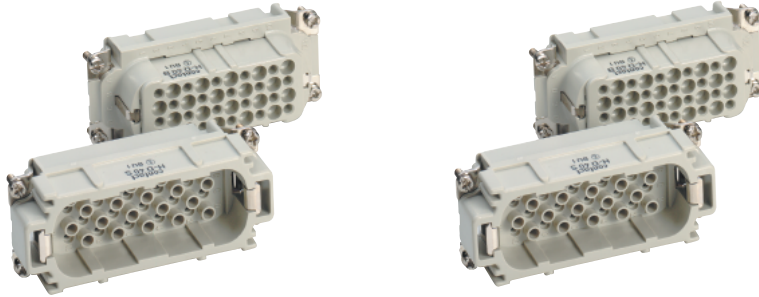

All dimensions are in mm.

Contacts Sold Separately

Plug	Receptacle
11265200 (2x)	11266200 (2X)



### MACHINE CONTACTS: DIAMETER 1.6 MM

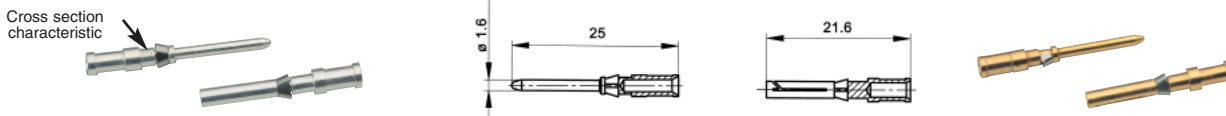

Bags of 100							
mm <sup>2</sup>	AWG	Silver		Gold		Stripping Length (mm)	# of Marking Tracks
		Pin	Socket	Pin	Socket		
0.14 - 0.37	26 - 22	13162000	13163000	13162500	13163500	8	1
0.5	20	13162100	13163100	13162600	13163600	8	2
0.75 - 1.0	18	13162200	13163200	13162700	13163700	8	3
1.5	16	13162300	13163300	13162800	13163800	8	4
2.5	14	13162400	13163400	13162900	13163900	5.8	5

Part number= 1 contact



**Crimp Tool**  
11147000



**Crimp Dies**  
11147100



**Locator**  
11147200

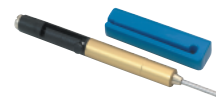

**Removal Tool:**  
11161000

# EPIC® Rectangular Connectors

HD Series



## HD 80 CRIMP TERMINATED: STAMPED & FORMED CONTACT INSERTS

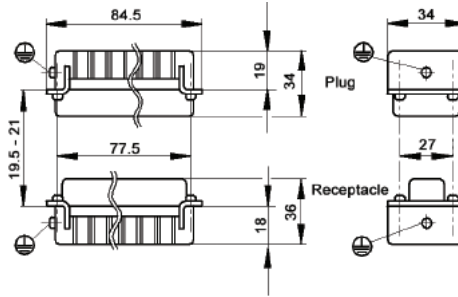

View from cable side

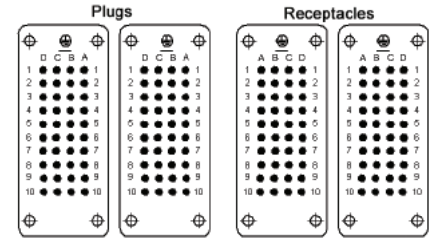

All dimensions are in mm.

Contacts Sold Separately

Plug	Receptacle
11265000 (2X)	11266000 (2X)



## STAMPED & FORMED CONTACTS: DIAMETER 1.6 MM

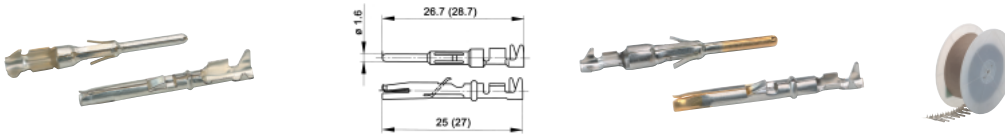

mm <sup>2</sup>	Stripping Length (mm)
0.14 - 0.5	2.5 - 0.5
0.5 - 1.5	3.5 - 0.5
1.5 - 2.5	3.5 - 0.5

		Bags of 100: Silver		Bags of 100: Gold		Reel of 100: Silver Left Hand Feed		Reel of 200: Silver Left Hand Feed	
mm <sup>2</sup>	AWG	Pin	Socket	Pin	Socket	Pin	Socket	Pin	Socket
0.14 - 0.5	26 - 20	11241100	11231100	11243100	11233100	-	-	11240700	11230700
0.5 - 1.5	20 - 16	11221000	11236100	11221300	11238100	-	-	11220700	11235700
1.5 - 2.5	16 - 14	11223500	11228500	-	-	11223000	11228000	-	-

mm <sup>2</sup>	AWG	Reel of 2000: Right Hand Feed- Silver		Reel of 2000: Right Hand Feed- Gold		Reel of 2000: Left Hand Feed- Silver		Reel of 2000: Left Hand Feed- Silver	
		Pin	Socket	Pin	Socket	Pin	Socket	Pin	Socket
0.14 - 0.5	26 - 20	11240000	11230000	-	-	11240400	11230400	11230500	11240500
0.5 - 1.5	20 - 16	11220000	11235000	11220100	11235200	11226000	11226500	-	-
1.5 - 2.5	16 - 14	-	-	-	-	11222700	11227700	-	-

Part number= 1 contact (bags) or 1 reel.



**Crimp Tool**  
11147000



**Locator**  
11147300

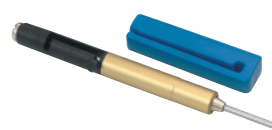

**Removal Tool: 11161000**



**Crimp Tool for Reel:**  
11153500



**Crimp Dies**

0.14-0.5:	11147170
0.5-1.5:	11147180
1.5-2.5:	11147190

**Crimp Dies for Reel:**

0.14-0.5:	11153600
0.5-1.5:	11153700
1.5-2.5:	11153800



### HD 128 CRIMP TERMINATED: MACHINE CONTACT INSERTS

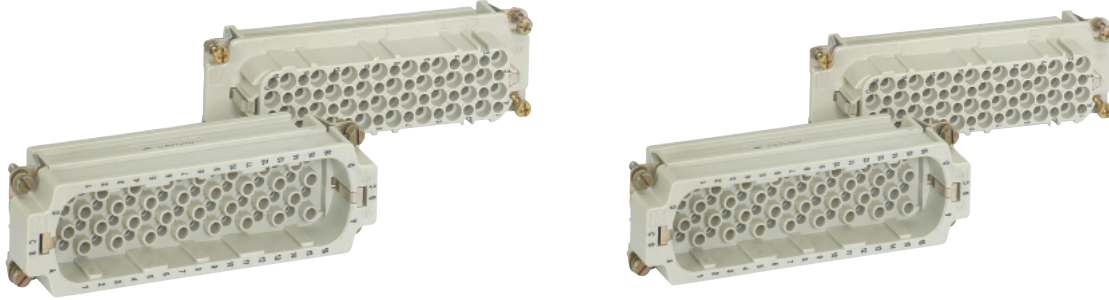

View from cable side

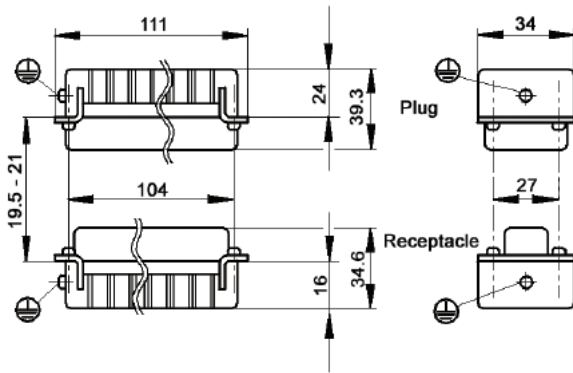

All dimensions are in mm.

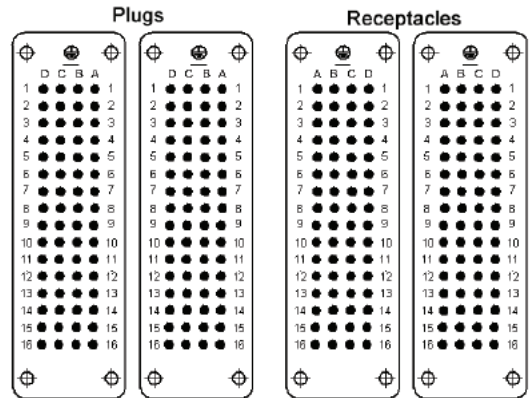

Contacts Sold Separately

Plug	Receptacle
11272000 (2x)	11273000 (2X)



### MACHINE CONTACTS: DIAMETER 1.6 MM

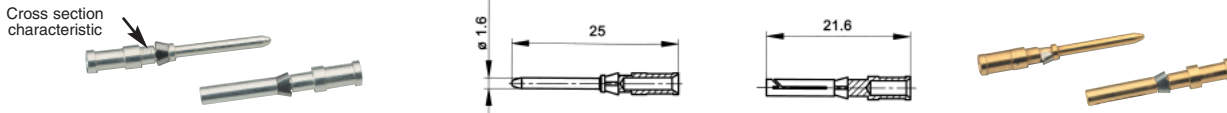

Bags of 100							
mm <sup>2</sup>	AWG	Silver		Gold		Stripping Length (mm)	# of Marking Tracks
		Pin	Socket	Pin	Socket		
0.14 - 0.37	26 - 22	13162000	13163000	13162500	13163500	8	1
0.5	20	13162100	13163100	13162600	13163600	8	2
0.75 - 1.0	18	13162200	13163200	13162700	13163700	8	3
1.5	16	13162300	13163300	13162800	13163800	8	4
2.5	14	13162400	13163400	13162900	13163900	5.8	5

Part number= 1 contact



Crimp Tool  
11147000



Crimp Dies  
11147100



Locator  
11147200

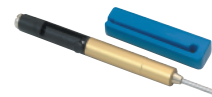

Removal Tool:  
11161000

# EPIC® Rectangular Connectors



HD Series

## HD 128 CRIMP TERMINATED: STAMPED & FORMED CONTACT INSERTS



Contacts Sold Separately

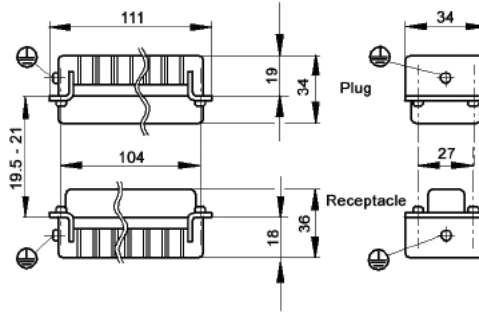

All dimensions are in mm.

View from cable side

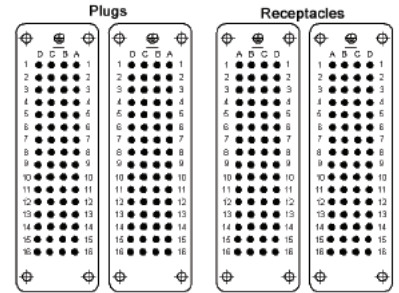

Plug	Receptacle
11270000 (2X)	11271000 (2X)

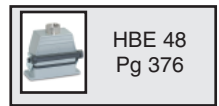

## STAMPED & FORMED CONTACTS: DIAMETER 1.6 MM

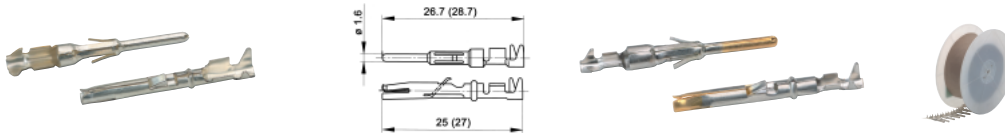

mm <sup>2</sup>	Stripping Length (mm)
0.14 - 0.5	2.5 - 0.5
0.5 - 1.5	3.5 - 0.5
1.5 - 2.5	3.5 - 0.5

		Bags of 100: Silver		Bags of 100: Gold		Reel of 100: Silver Left Hand Feed		Reel of 200: Silver Left Hand Feed	
mm <sup>2</sup>	AWG	Pin	Socket	Pin	Socket	Pin	Socket	Pin	Socket
0.14 - 0.5	26 - 20	11241100	11231100	11243100	11233100	-	-	11240700	11230700
0.5 - 1.5	20 - 16	11221000	11236100	11221300	11238100	-	-	11220700	11235700
1.5 - 2.5	16 - 14	11223500	11228500	-	-	11223000	11228000	-	-

mm <sup>2</sup>	AWG	Reel of 2000: Right Hand Feed- Silver		Reel of 2000: Right Hand Feed- Gold		Reel of 2000: Left Hand Feed- Silver		Reel of 2000: Left Hand Feed- Silver	
		Pin	Socket	Pin	Socket	Pin	Socket	Pin	Socket
0.14 - 0.5	26 - 20	11240000	11230000	-	-	11240400	11230400	11230500	11240500
0.5 - 1.5	20 - 16	11220000	11235000	11220100	11235200	11226000	11226500	-	-
1.5 - 2.5	16 - 14	-	-	-	-	11222700	11227700	-	-

Part number= 1 contact (bags) or 1 reel.



**Crimp Tool**  
11147000



**Locator**  
11147300

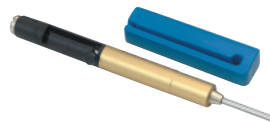

**Removal Tool:** 11161000



**Crimp Tool for Reel:**  
11153500



**Crimp Dies**

0.14-0.5:	11147170
0.5-1.5:	11147180
1.5-2.5:	11147190

**Crimp Dies for Reel:**

0.14-0.5:	11153600
0.5-1.5:	11153700
1.5-2.5:	11153800

