

# EPIC® Rectangular Connectors

HBE Series

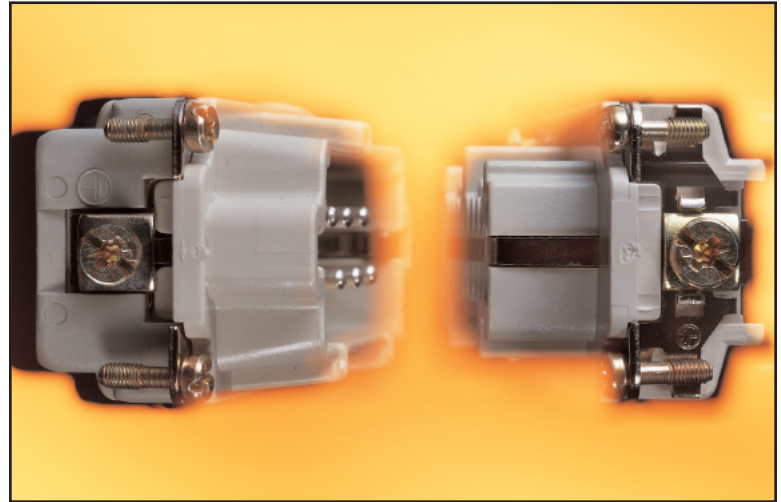

The HBE series inserts are suitable for applications with high voltages and current. The inserts can be terminated in a variety of ways: screw, crimp, or “spring” cage clamp.



## TECHNICAL DATA

**Number of Contacts:** 6, 10, 16, 24, 32, 48 (+PE)

### Screw Termination & Crimp Termination:

**Rated Voltage:** VDE: 500V EPIC® HBE 6 - 48      UL: 600V EPIC® HBE 6 - 48  
CSA: 600V EPIC® HBE 6 - 48

**Rated Current:** VDE: 16A EPIC® HBE 6 - 48      UL: 16A EPIC® HBE 6 - 48  
CSA: 16A EPIC® HBE 6 - 48

**Temperature Range:** -40°C to +125°C

### Cage Clamp:

**Rated Voltage:** VDE: 500V EPIC® HBE 6 - 48      UL: 600V EPIC® HBE 6 - 48  
CSA: 600V EPIC® HBE 6 - 48

**Rated Current:** VDE: 16A EPIC® HBE 6 - 48      UL: 16A EPIC® HBE 6 - 48  
CSA: 16A EPIC® HBE 6 - 48

**Pollution Level:** 3  
**Dimensioning Transient:** 6 kV

### Termination Type:

	mm <sup>2</sup>	AWG
<b>Screw Termination:</b>	0.5 - 2.5 mm <sup>2</sup>	20 - 14
<b>Crimp Termination:</b>	0.5 - 4.0 mm <sup>2</sup>	20 - 12
<b>Cage Clamp Termination:</b>	0.5 - 2.5 mm <sup>2</sup>	20 - 14

### Contacts:

**Screw Termination:** Copper alloy, silver plated  
**Crimp Termination:** Copper alloy, silver plated/ gold plated  
**Cage Clamp Termination:** Copper alloy, silver plated  
**Mating Cycles:** 100 (higher mating cycles depending on the application)

### Contact Resistance:

**Screw Termination:** <2 mOhm  
**Crimp Termination:** <2 mOhm  
**Cage Clamp termination:** 1.5 - 4 mOhm

# EPIC<sup>®</sup> Rectangular Connectors

HBE Series

## HBE INSERTS: DERATING CURVES

**HBE SCREW TERMINATED:  
1.5 mm<sup>2</sup> (16 AWG)**

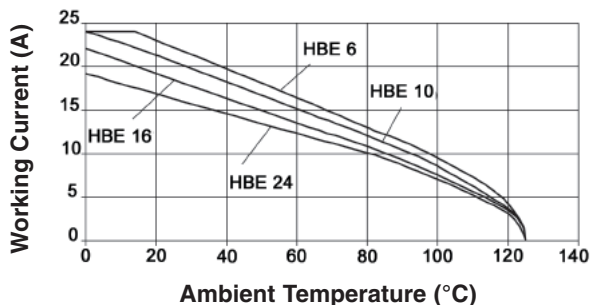

**HBE SCREW TERMINATED:  
2.5 mm<sup>2</sup> (14 AWG)**

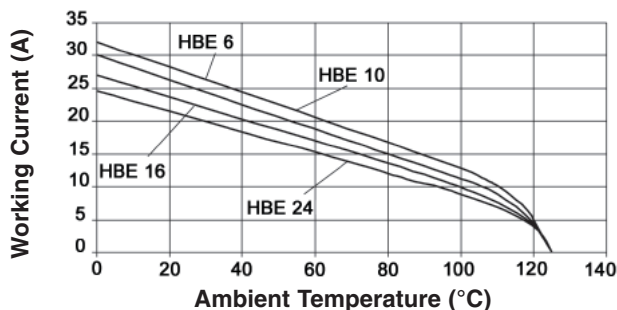

**HBE CRIMP TERMINATED:  
1.5 mm<sup>2</sup> (16 AWG)**

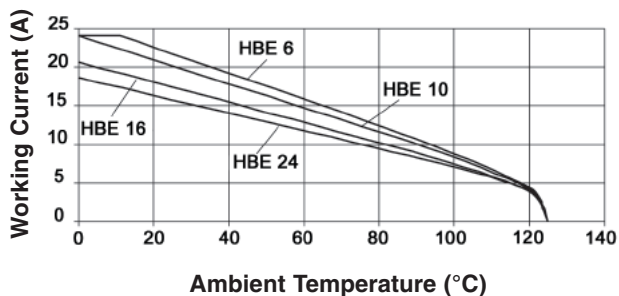

**HBE CRIMP TERMINATED:  
2.5 mm<sup>2</sup> (14 AWG)**

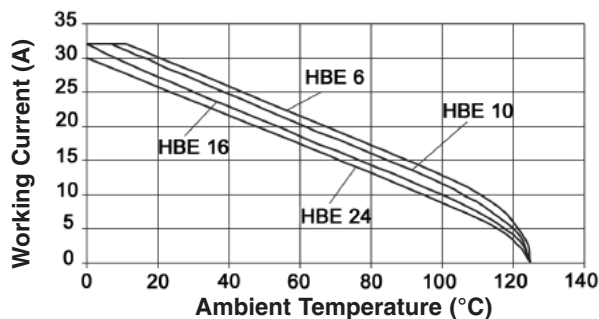

**HBE CAGE CLAMP:  
1.5 mm<sup>2</sup> (16 AWG)**

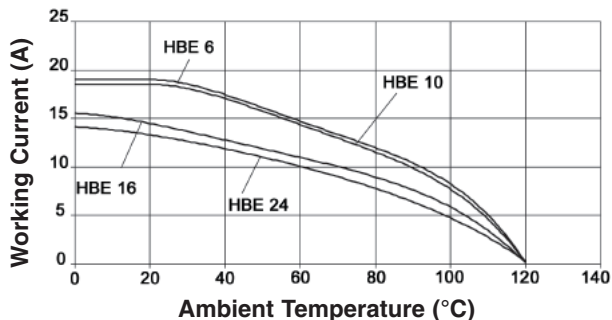

**HBE CAGE CLAMP:  
2.5 mm<sup>2</sup> (14 AWG)**

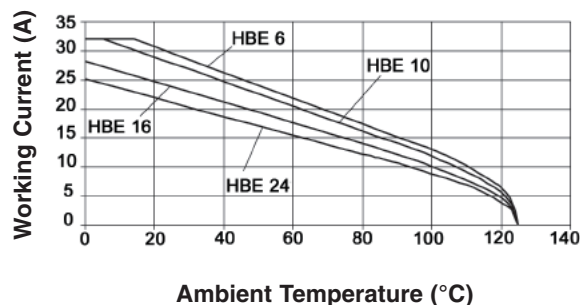

### HBE 6 SCREW & CRIMP TERMINATED INSERTS

#### SCREW TERMINATED

#### CRIMP TERMINATED

View from Cable Side

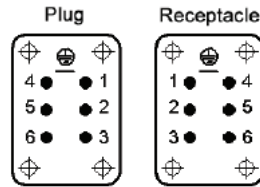

Contacts Sold Separately

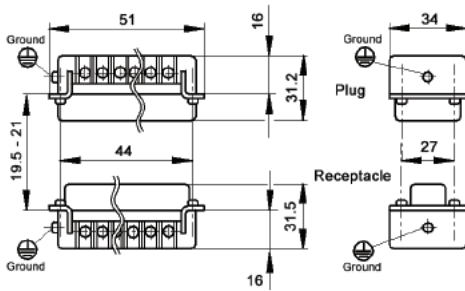

All dimensions are in mm.

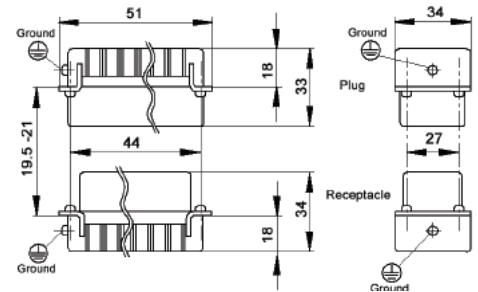

Description	Plug	Receptacle
Screw Terminated with wire protection	10190000	10191000
Screw Terminated without wire protection	10190100	10191100
Crimp Terminated: Machine	10180000	10181000



### MACHINED CONTACTS: DIAMETER 2.5 MM<sup>2</sup>

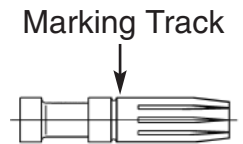
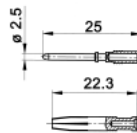

Bags of 100							
mm <sup>2</sup>	AWG	Silver		Gold		Stripping Length (mm)	# of Marking Tracks
		Pin	Socket	Pin	Socket		
0.5	20	11190000	11195000	11192000	11197000	Pin=7.4, Socket =7.3	-
.75 - 1.0	18	11190100	11195100	11192100	11197100	Pin=7.4, Socket =7.3	1
1.5	16	11190200	11195200	11192200	11197200	Pin=7.4, Socket =7.3	2
2.5	14	11190300	11195300	-	-	Pin=7.4, Socket =7.3	3
4.0	12	11190400	11195400	-	-	Pin=7.4, Socket =7.3	-

Part number= 1 contact



**Crimp Tool**  
11147000



**Crimp Dies**  
11147100



**Locator**  
11147200

For removal of contacts use a slotted screwdriver.  
No special tool is necessary.

Please note that the crimp range for this tool is 0.14 to 4.0 mm<sup>2</sup> (AWG 26 - 12) with the appropriate crimp dies.

### HBE 6 SCREWLESS SPRING CAGE CLAMP INSERTS

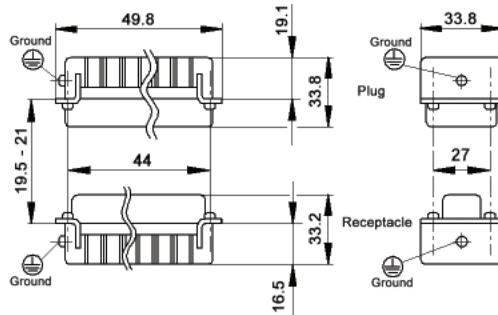

View from Cable Side

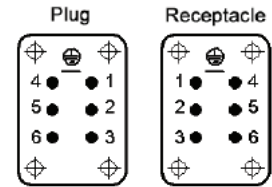

All dimensions are in mm.



Description	Plug	Receptacle
Screwless Cage Clamp	10400000	10401000

### SCREW TERMINATED TERMINAL BLOCK INSERTS



View from Cable Side

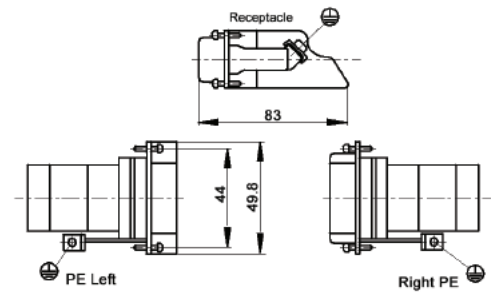
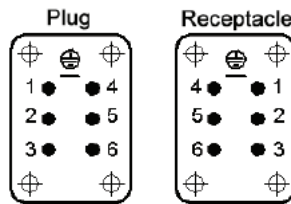

All dimensions are in mm.



These terminal block inserts only fit in HBE 6 panel mount bases

Description	Receptacle
Terminal Block: Right Ground	70311100
Terminal Block: Left Ground	70310100

One terminal block insert mates with one screw terminated insert.

### HBE 10 SCREW & CRIMP TERMINATED INSERTS

#### SCREW TERMINATED

#### CRIMP TERMINATED

View from Cable Side

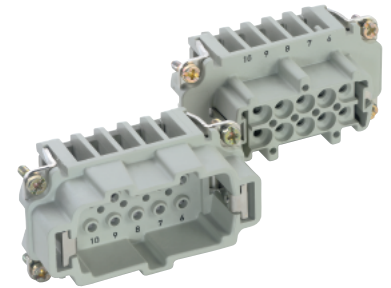
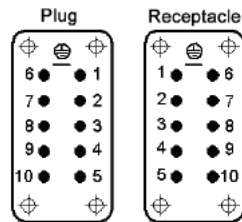
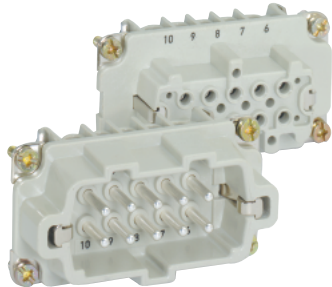

Contacts Sold Separately

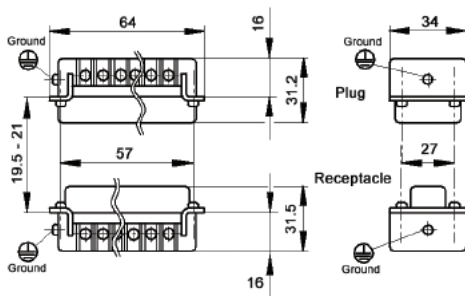

All dimensions are in mm.

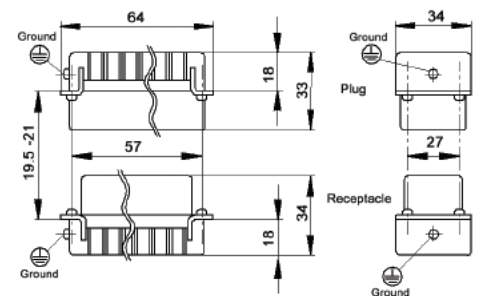

Description	Plug	Receptacle
Screw Terminated with wire protection	10192000	10193000
Screw Terminated without wire protection	10192100	10193100
Crimp Terminated: Machine	10182000	10183000



### MACHINED CONTACTS: DIAMETER 2.5 MM<sup>2</sup>

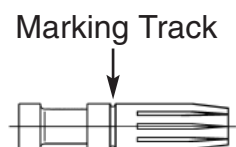

Bags of 100							
mm <sup>2</sup>	AWG	Silver		Gold		Stripping Length (mm)	# of Marking Tracks
		Pin	Socket	Pin	Socket		
0.5	20	11190000	11195000	11192000	11197000	Pin=7.4, Socket =7.3	-
.75 - 1.0	18	11190100	11195100	11192100	11197100	Pin=7.4, Socket =7.3	1
1.5	16	11190200	11195200	11192200	11197200	Pin=7.4, Socket =7.3	2
2.5	14	11190300	11195300	-	-	Pin=7.4, Socket =7.3	3
4.0	12	11190400	11195400	-	-	Pin=7.4, Socket =7.3	-

Part number= 1 contact



**Crimp Tool**  
11147000



**Crimp Dies**  
11147100



**Locator**  
11147200

For removal of contacts use a slotted screwdriver.  
No special tool is necessary.

Please note that the crimp range for this tool is 0.14 to 4.0 mm<sup>2</sup> (AWG 26 - 12) with the appropriate crimp dies.

### HBE 10 SCREWLESS SPRING CAGE CLAMP INSERTS

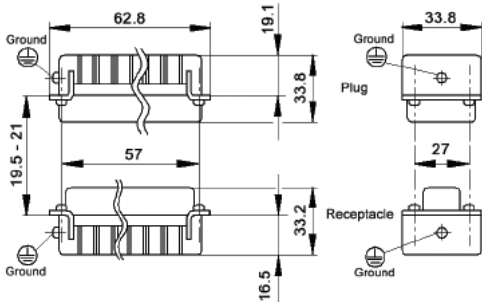

All dimensions are in mm.

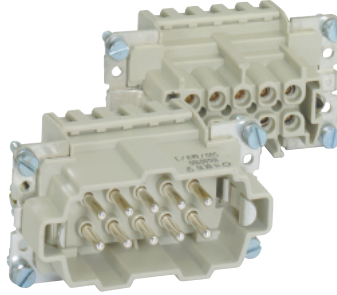

View from Cable Side

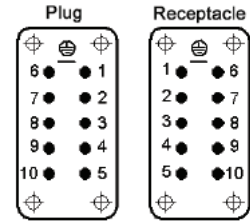

Description	Plug	Receptacle
Screwless Cage Clamp	10400100	10401100

### HBE 10 SCREW TERMINATED TERMINAL BLOCK INSERTS

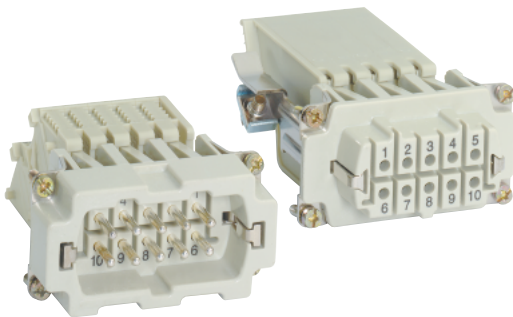

View from Cable Side

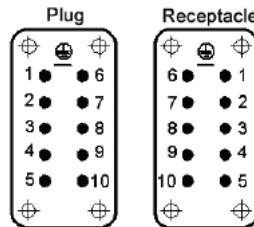

All dimensions are in mm.

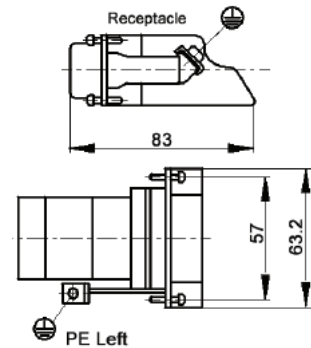

These terminal block inserts only fit in HBE 10 panel mount bases

One terminal block insert mates with one screw terminated insert.

Description	Receptacle
Terminal Block: Left Ground	70312100

### HBE 16 SCREW & CRIMP TERMINATED INSERTS

#### SCREW TERMINATED

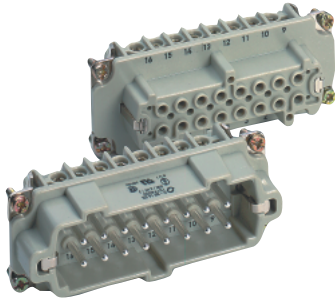

View from Cable Side

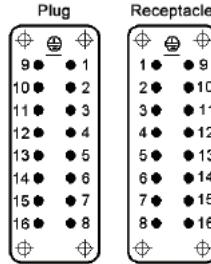

#### CRIMP TERMINATED



Contacts Sold Separately

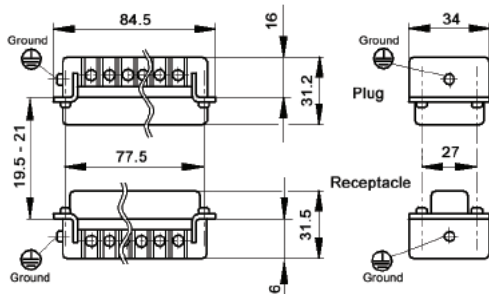

All dimensions are in mm.

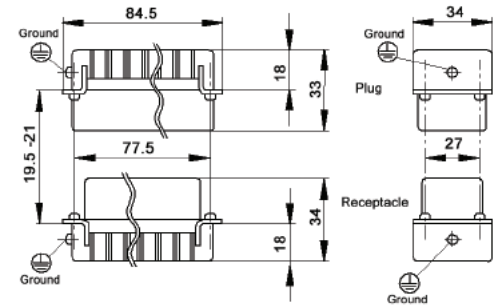

Description	Plug	Receptacle
Screw Terminated with wire protection	10194000	10195000
Screw Terminated without wire protection	10194100	10195100
Crimp Terminated: Machine	10184000	10185000



### MACHINED CONTACTS: DIAMETER 2.5 MM<sup>2</sup>

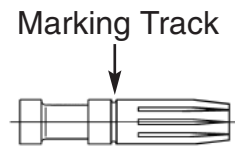
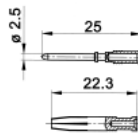

Bags of 100							
mm <sup>2</sup>	AWG	Silver		Gold		Stripping Length (mm)	# of Marking Tracks
		Pin	Socket	Pin	Socket		
0.5	20	11190000	11195000	11192000	11197000	Pin=7.4, Socket =7.3	-
.75 - 1.0	18	11190100	11195100	11192100	11197100	Pin=7.4, Socket =7.3	1
1.5	16	11190200	11195200	11192200	11197200	Pin=7.4, Socket =7.3	2
2.5	14	11190300	11195300	-	-	Pin=7.4, Socket =7.3	3
4.0	12	11190400	11195400	-	-	Pin=7.4, Socket =7.3	-

Part number= 1 contact



**Crimp Tool**  
11147000



**Crimp Dies**  
11147100



**Locator**  
11147200

For removal of contacts use a slotted screwdriver.  
No special tool is necessary.

Please note that the crimp range for this tool is 0.14 to 4.0 mm<sup>2</sup> (AWG 26 - 12) with the appropriate crimp dies.

### HBE 16 SCREWLESS SPRING CAGE CLAMP INSERTS

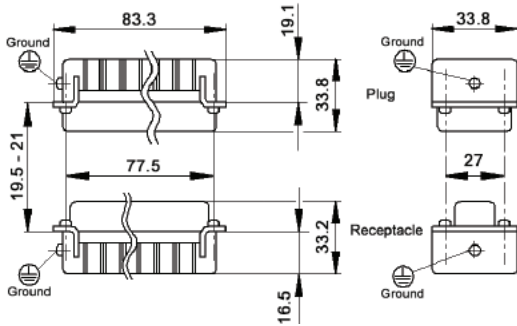

All dimensions are in mm.

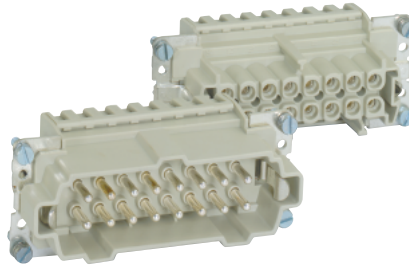

View from Cable Side

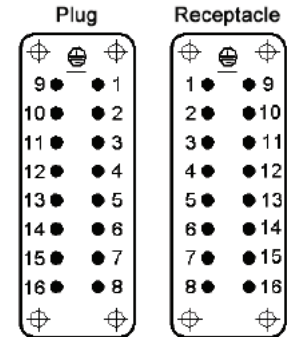

Description	Plug	Receptacle
Screwless Cage Clamp	10400200	10401200



### HBE 16 SCREW TERMINATED TERMINAL BLOCK INSERTS

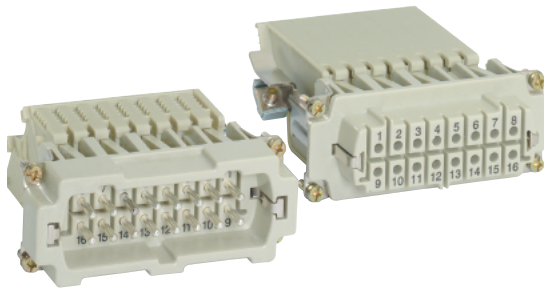

View from Cable Side

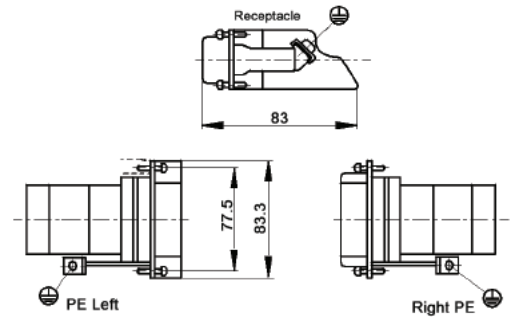
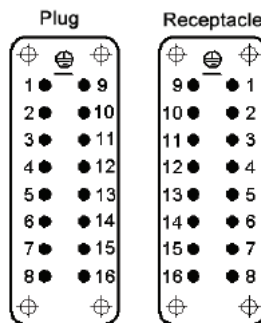

All dimensions are in mm.



These terminal block inserts only fit in HBE 16 panel mount bases

One terminal block insert mates with one screw terminated insert.

Description	Receptacle
Terminal Block: Right Ground	70315100
Terminal Block: Left Ground	70314100

### HBE 24 SCREW & CRIMP TERMINATED INSERTS

#### SCREW TERMINATED

View from Cable Side

#### CRIMP TERMINATED

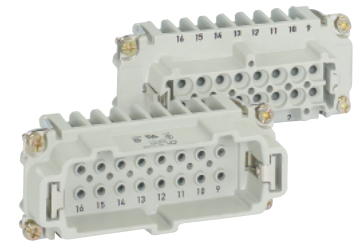
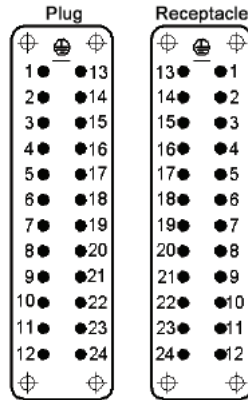
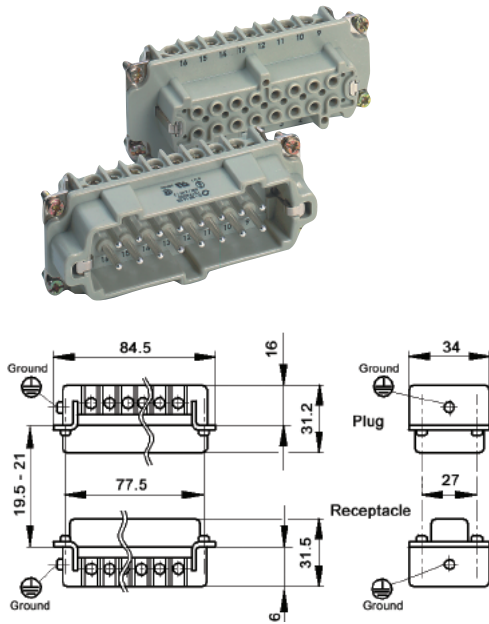

Contacts Sold Separately

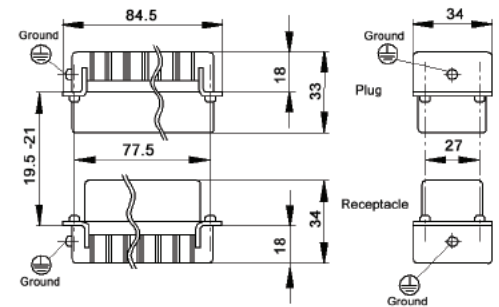

All dimensions are in mm.

Description	Plug	Receptacle
Screw Terminated with wire protection	10196000	10197000
Screw Terminated without wire protection	10196100	10197100
Crimp Terminated: Machine	10186000	10187000



### MACHINED CONTACTS: DIAMETER 2.5 MM<sup>2</sup>



Bags of 100							
mm <sup>2</sup>	AWG	Silver		Gold		Stripping Length (mm)	# of Marking Tracks
		Pin	Socket	Pin	Socket		
0.5	20	11190000	11195000	11192000	11197000	Pin=7.4, Socket =7.3	-
.75 - 1.0	18	11190100	11195100	11192100	11197100	Pin=7.4, Socket =7.3	1
1.5	16	11190200	11195200	11192200	11197200	Pin=7.4, Socket =7.3	2
2.5	14	11190300	11195300	-	-	Pin=7.4, Socket =7.3	3
4.0	12	11190400	11195400	-	-	Pin=7.4, Socket =7.3	-

Part number= 1 contact



**Crimp Tool**  
11147000



**Crimp Dies**  
11147100



**Locator**  
11147200

For removal of contacts use a slotted screwdriver.  
No special tool is necessary.

Please note that the crimp range for this tool is 0.14 to 4.0 mm<sup>2</sup> (AWG 26 - 12) with the appropriate crimp dies.

### HBE 24 SCREWLESS SPRING CAGE CLAMP INSERTS

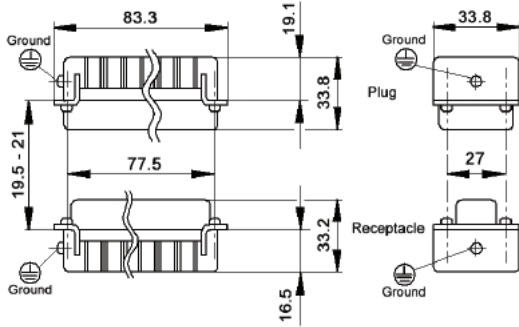

All dimensions are in mm.

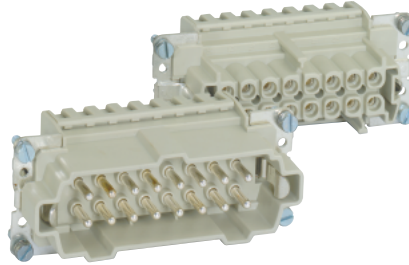

View from Cable Side

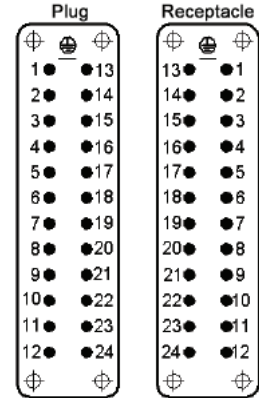

Description	Plug	Receptacle
Screwless Cage Clamp	10400300	10401300



### HBE 24 SCREW TERMINATED TERMINAL BLOCK INSERTS

View from Cable Side

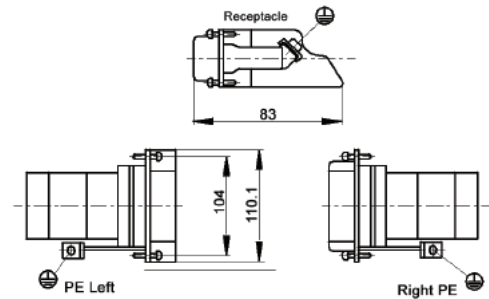
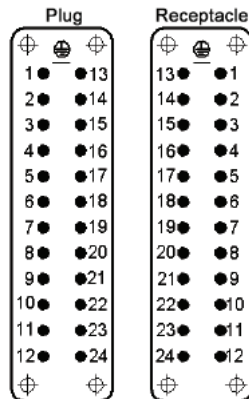
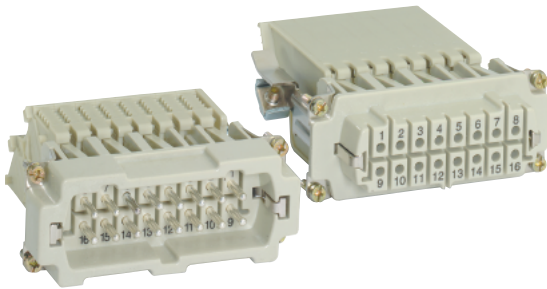

All dimensions are in mm.

These terminal block inserts only fit in HBE 24 panel mount bases

Description	Receptacle
Terminal Block: Right Ground	70317100
Terminal Block: Left Ground	70316100

One terminal block insert mates with one screw terminated insert.

### HBE 32 SCREW & CRIMP TERMINATED INSERTS

#### SCREW TERMINATED

View from Cable Side

#### CRIMP TERMINATED

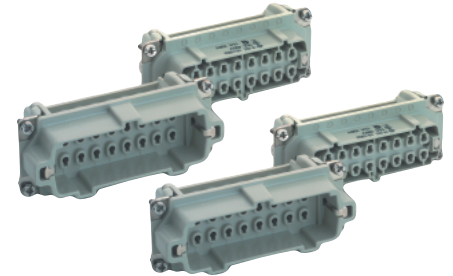
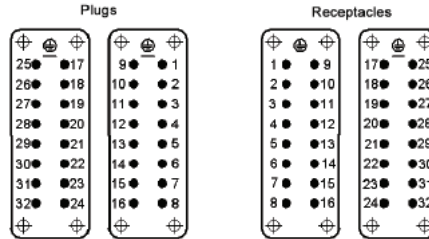
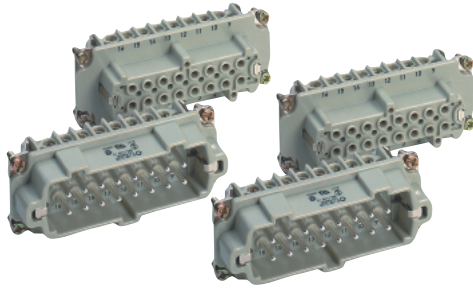

Contacts Sold Separately

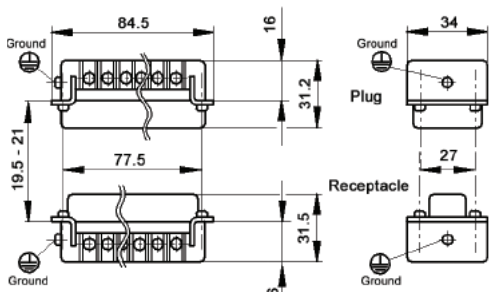

All dimensions are in mm.

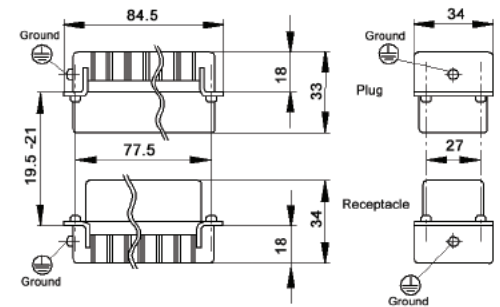

HBE 32  
Pg 374

Crimp Contacts  
Page 271

Description	Plug	Receptacle
Screw Terminated with wire protection (#1-16)	10194000	10195000
Screw Terminated with wire protection (#17-32)	10202000	10203000
Screw Terminated without wire protection (#1-16)	10194100	10195100
Screw Terminated without wire protection (#17-32)	10202100	10203100
Crimp Terminated: Machine (#1-16)	10184000	10185000
Crimp Terminated: Machine (#17-32)	10184200	10185200

### HBE 32 SCREWLESS SPRING CAGE CLAMP INSERTS

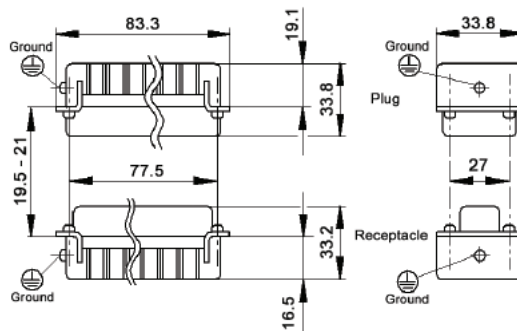
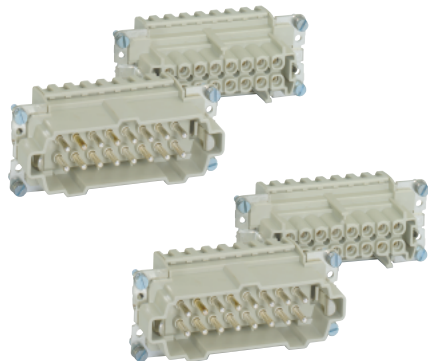

All dimensions are in mm.

View from Cable Side

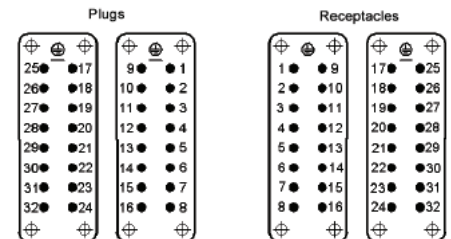

Description	Plug	Receptacle
Screwless Cage Clamp (#1-16)	10400200	10401200
Screwless Cage Clamp (#17-32)	10400400	10401400



HBE 32  
Pg 374

### HBE 48 SCREW & CRIMP TERMINATED INSERTS

#### SCREW TERMINATED

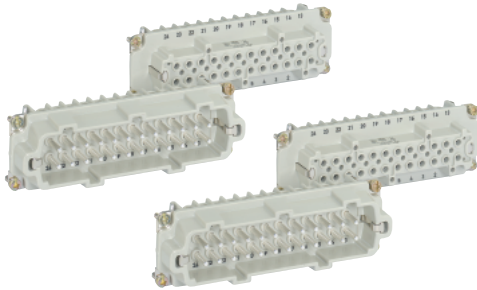

View from Cable Side

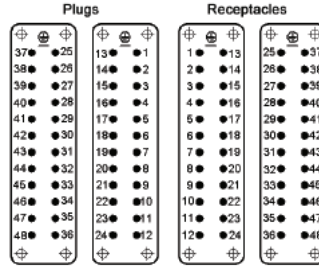

#### CRIMP TERMINATED



Contacts Sold Separately

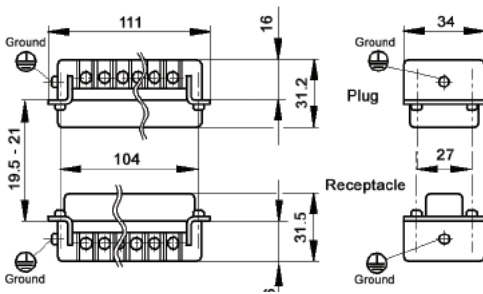

All dimensions are in mm.

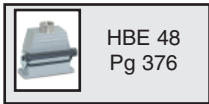
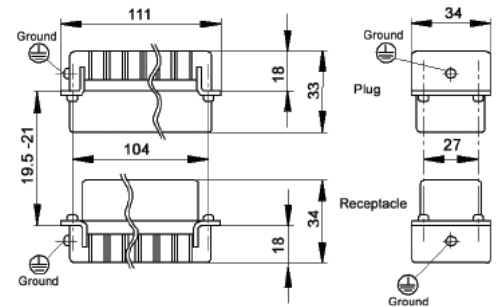

HBE 48  
Pg 376

Description	Plug	Receptacle
Screw Terminated with wire protection (#1-24)	10196000	10197000
Screw Terminated with wire protection (#25-48)	10204000	10205000
Screw Terminated without wire protection (#1-24)	10196100	10197100
Screw Terminated without wire protection (#25-48)	10204100	10205100
Crimp Terminated: Machine (#1-24)	10186000	10187000
Crimp Terminated: Machine (#25-48)	10186200	10187200

Crimp  
Contacts  
Page 271

### SCREWLESS SPRING CAGE CLAMP INSERTS

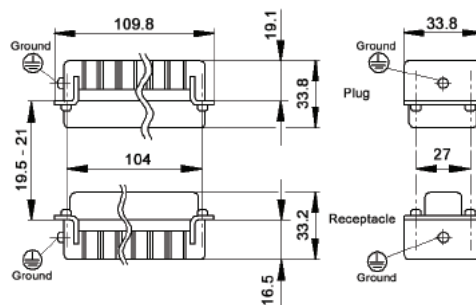
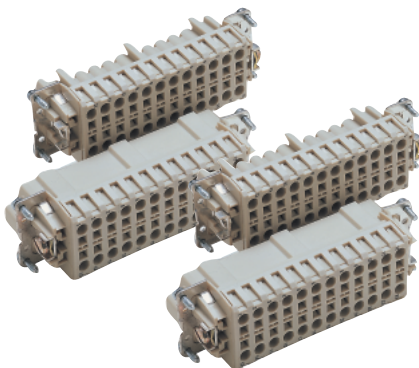

All dimensions are in mm.

View from Cable Side

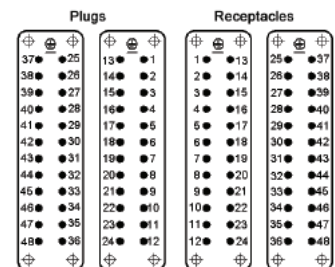

Description	Plug	Receptacle
Screwless Cage Clamp (#1-24)	10400300	10401300
Screwless Cage Clamp (#25-48)	10400500	10401500



HBE 48  
Pg 376