

BUS Cordsets, Receptacles, Tees

DeviceNet • ProfiBus • Ethernet

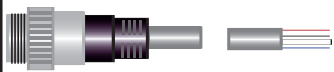

DeviceNet: Single Ended Cordsets with Minifast Connectors

 <p>DN4110001F-XXX Flex Male Straight to Flying Leads DN4110001S-XXX Static Male Straight to Flying Leads</p>	 <p>DN4110002F-XXX Flex Male Right Angle Flying Leads DN4110002S-XXX Static Male Right Angle Flying Leads</p>
 <p>DN4110003F-XXX Flex Female Straight to Flying Leads DN4110003S-XXX Static Female Straight to Flying Leads</p>	 <p>DN4110004F-XXX Flex Female Right Angle to Flying Leads DN4110004S-XXX Static Female Right Angle to Flying Leads</p>

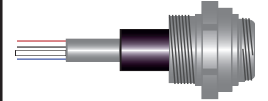
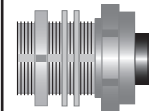
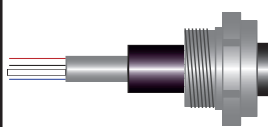
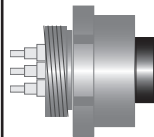
DeviceNet: Extension Ended Cordsets with Thick Panel Mount Receptacles

 <p>DN4110005F-XXX Flex Male 5-Pin 1/2" NPT Receptacle DN4110005S-XXX Static Male 5-Pin 1/2" NPT Receptacle</p>	 <p>DN4110051F-XXX Flex Male to Female Feed-Through Receptacle DN4110051S-XXX Static Male to Female Feed-Through Receptacle</p>
 <p>DN4110006F-XXX Flex Female 5-Pin 1/2" NPT Receptacle DN4110006S-XXX Static Female 5-Pin 1/2" NPT Receptacle</p>	 <p>DN4110007F-XXX Flex Female 5-Pin 1/2" NPT Housing Receptacle with PCB Leads DN4110007S-XXX Static Female 5-Pin 1/2" NPT Housing Receptacle with PCB Leads</p>

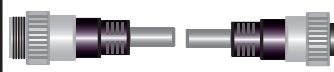
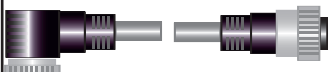
DeviceNet: Thick Trunk Extension Ended Cordsets

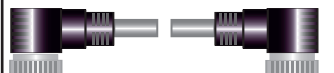
 <p>DN4110008F-XXX Flex Male Straight to Female Straight DN4110008S-XXX Static Male Straight to Female Straight</p>	 <p>DN4110010F-XXX Flex Male Right-Angle to Female Straight DN4110010S-XXX Static Male Right-Angle to Female Straight</p>
 <p>DN4110009F-XXX Flex Male Straight to Female Right-Angle DN4110009S-XXX Static Male Straight to Female Right-Angle</p>	 <p>DN4110011F-XXX Flex Male Right-Angle to Female Right-Angle DN4110011S-XXX Static Male Right-Angle to Female Right-Angle</p>

DeviceNet: Bus Drop Tees

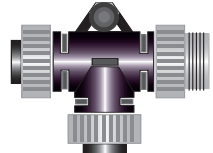
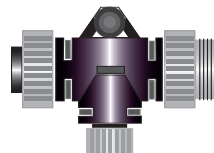
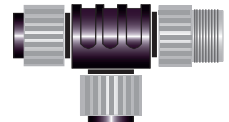

 <p>DN4110012F-XXX Flex Minifast Bus In/Out, Minifast Drop (1 Male, 2 Female) DN4110012S-XXX Static Minifast Bus In/Out, Minifast Drop (1 Male, 2 Female)</p>	 <p>DN4110014F-XXX Flex Minifast Bus In/Out, Eurofast Drop (1 Male, 2 Female) DN4110014S-XXX Static Minifast Bus In/Out, Eurofast Drop (1 Male, 2 Female)</p>
 <p>DN4110013F-XXX Flex Eurofast Bus In/Out, Eurofast Drop (1 Male, 2 Female)</p>	<p>DN4110013S-XXX Static Eurofast Bus In/Out, Eurofast Drop (1 Male, 2 Female)</p>

DeviceNet cordsets are for Trunk applications. Replace the XXX with the desired cable length in feet.



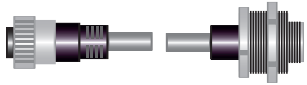
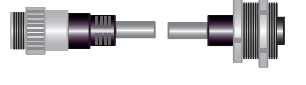
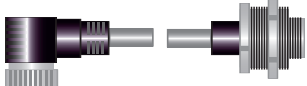

BUS Cordsets, Receptacles, Tees

DeviceNet • ProfiBus • Ethernet

DeviceNet: Thick Back Panel Mount Trunk Extension Cordsets

 <p>DN4110015F-XXX Flex Female Straight to Male Back Panel Mount Receptacle DN4110015S-XXX Static Female Straight to Male Back Panel Mount Receptacle</p>	 <p>DN4110017F-XXX Flex Male Straight to Female Back Panel Mount Receptacle DN4110017S-XXX Static Male Straight to Female Back Panel Mount Receptacle</p>
 <p>DN4110016F-XXX Flex Female Right-Angle to Male Back Panel Mount Receptacle DN4110016S-XXX Static Female Right-Angle to Male Back Panel Mount Receptacle</p>	 <p>DN4110018F-XXX Flex Male Right-Angle to Female Back Panel Mount Receptacle DN4110018S-XXX Static Male Right-Angle to Female Back Panel Mount Receptacle</p>

DeviceNet: Thin Drop Single Ended Cordsets

 <p>DN4110019F-XXX Flex Eurofast Male Straight to Flying Leads DN4110019S-XXX Static Eurofast Male Straight to Flying Leads</p>	 <p>DN4110021F-XXX Flex Eurofast Female Straight to Flying Leads DN4110021S-XXX Static Eurofast Female Straight to Flying Leads</p>
 <p>DN4110020F-XXX Flex Eurofast Male Right-Angle to Flying Leads DN4110020S-XXX Static Eurofast Male Right-Angle to Flying Leads</p>	 <p>DN4110022F-XXX Flex Eurofast Female Right-Angle to Flying Leads DN4110022S-XXX Static Eurofast Female Right-Angle to Flying Leads</p>

DeviceNet: Thin Drop Single Extension Cordsets



 <p>DN4110023F-XXX Flex Eurofast Male Straight to Eurofast Female Straight DN4110023S-XXX Static Eurofast Male Straight to Eurofast Female Straight</p>	 <p>DN4110029F-XXX Flex Minifast Male Right-Angle to Eurofast Female Straight DN4110029S-XXX Static Minifast Male Right-Angle to Eurofast Female Straight</p>
 <p>DN4110024F-XXX Eurofast Male Straight to Eurofast Female Right-Angle DN4110024S-XXX Static Eurofast Male Straight to Eurofast Female Right-Angle</p>	 <p>DN4110030F-XXX Flex Minifast Male Right-Angle to Eurofast Female Right-Angle DN4110030S-XXX Static Minifast Male Right-Angle to Eurofast Female Right-Angle</p>
 <p>DN4110025F-XXX Flex Eurofast Male Right-Angle to Eurofast Female Straight DN4110025S-XXX Static Eurofast Male Right-Angle to Eurofast Female Straight</p>	 <p>DN4110031F-XXX Flex Minifast Female Straight to Eurofast Male Straight DN4110031S-XXX Static Minifast Female Straight to Eurofast Male Straight</p>
 <p>DN4110026F-XXX Flex Eurofast Male Right-Angle to Eurofast Female Right-Angle DN4110026S-XXX Static Eurofast Male Right-Angle to Eurofast Female Right-Angle</p>	 <p>DN4110032F-XXX Flex Minifast Female Straight to Eurofast Male Right-Angle DN4110032S-XXX Static Minifast Female Straight to Eurofast Male Right-Angle</p>

DeviceNet cordsets are for Trunk applications. Replace the XXX with the desired cable length in feet.

BUS Cordsets, Receptacles, Tees

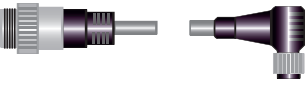
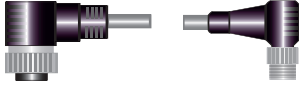
DeviceNet • ProfiBus • Ethernet

DeviceNet: Thin Drop Single Extension Cordsets	
 <p>DN4110027F-XXX Flex Minifast Male Straight to Eurofast Female Straight DN4110027S-XXX Static Minifast Male Straight to Eurofast Female Straight</p>	 <p>DN4110033F-XXX Flex Minifast Female Right-Angle to Eurofast Male Straight DN4110033S-XXX Static Minifast Female Right-Angle to Eurofast Male Straight</p>
 <p>DN4110028F-XXX Flex Minifast Male Straight to Eurofast Female Right-Angle DN4110028S-XXX Static Minifast Male Straight to Eurofast Female Right-Angle</p>	 <p>DN4110034F-XXX Flex Minifast Female Right-Angle to Eurofast Male Right-Angle DN4110034S-XXX Static Minifast Female Right-Angle to Eurofast Male Right-Angle</p>

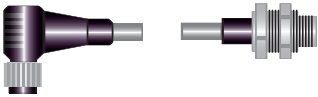
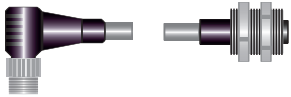
DeviceNet: Eurofast Thin Back Panel Mount Extension Cordsets	
 <p>DN4110035F-XXX Flex Female Straight to Male Back Panel Mount Receptacle DN4110035S-XXX Static Female Straight to Male Back Panel Mount Receptacle</p>	 <p>DN4110037F-XXX Flex Male Straight to Female Back Panel Mount Receptacle DN4110037S-XXX Static Male Straight to Female Back Panel Mount Receptacle</p>
 <p>DN4110036F-XXX Flex Female Right-Angle to Male Back Panel Mount Receptacle DN4110036S-XXX Static Female Right-Angle to Male Back Panel Mount Receptacle</p>	 <p>DN4110038F-XXX Flex Male Right-Angle to Female Back Panel Mount Receptacle DN4110038S-XXX Static Male Right-Angle to Female Back Panel Mount Receptacle</p>

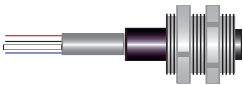
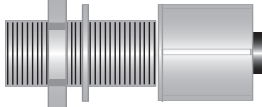
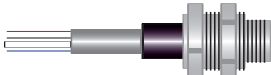
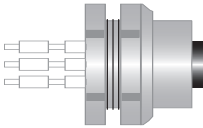
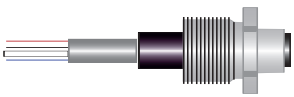
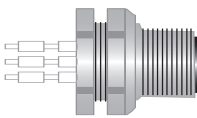
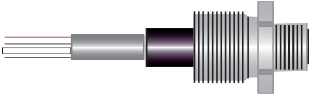

DeviceNet: Eurofast Thin Receptacles	
 <p>DN4110039F-XXX Flex Eurofast Female Back Mount Receptacle DN4110039S-XXX Static Eurofast Female Back Mount Receptacle</p>	 <p>DN4110043F-XXX Flex Eurofast Female to Male Feed-Through Receptacle DN4110043S-XXX Static Eurofast Female to Male Feed-Through Receptacle</p>
 <p>DN4110040F-XXX Flex Eurofast Male Back Mount Receptacle DN4110040S-XXX Static Eurofast Male Back Mount Receptacle</p>	 <p>DN4110044F-XXX Flex Eurofast Female Back Mount Receptacle with PCB Leads DN4110044S-XXX Static Eurofast Female Back Mount Receptacle with PCB Leads</p>
 <p>DN4110041F-XXX Flex Eurofast Female 1/2" NPT Receptacle DN4110041S-XXX Static Eurofast Female 1/2" NPT Receptacle</p>	 <p>DN4110045F-XXX Flex Eurofast Male Back Mount Receptacle with PCB Leads DN4110045S-XXX Static Eurofast Male Back Mount Receptacle with PCB Leads</p>
 <p>DN4110042F-XXX Flex Eurofast Male 1/2" NPT Receptacle</p>	<p>DN4110042S-XXX Static Eurofast Male 1/2" NPT Receptacle</p>

DeviceNet cordsets are for Trunk applications. Replace the XXX with the desired cable length in feet.

BUS Cordsets, Receptacles, Tees

DeviceNet • ProfiBus • Ethernet

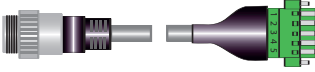
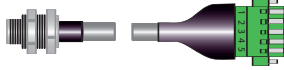
DeviceNet: Thin Open Style Termination Cordsets

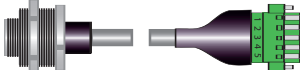
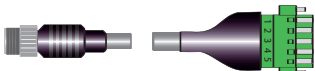
 <p>DN4110046F-XXX Flex Minifast Male Straight to 5-Pin Terminal Connector DN4110046S-XXX Static Minifast Male Straight to 5-Pin Terminal Connector</p>	 <p>DN4110049F-XXX Flex Eurofast Male Back Mount Receptacle to 5-Pin Terminal Connector DN4110049S-XXX Static Eurofast Male Back Mount Receptacle to 5-Pin Terminal Connector</p>
 <p>DN4110047F-XXX Flex 5-Pin Terminal Connector to Flying Leads DN4110047S-XXX Static 5-Pin Terminal Connector to Flying Leads</p>	 <p>DN4110050F-XXX Flex Minifast Male Back Panel Mount Receptacle to 5-Pin Terminal Connector DN4110050S-XXX Static Male Right-Angle to Female Back Panel Mount Receptacle</p>
 <p>DN4110048F-XXX Flex Eurofast Male Straight to 5-Pin Terminal Connector DN4110048S-XXX Static Eurofast Male Straight to 5-Pin Terminal Connector</p>	

DeviceNet cordsets are for Trunk applications. Replace the XXX with the desired cable length in feet.

Replace the XXX with the desired cable length in feet.